



2017 Truck New Item Product Collection

UPauto.com/truck

3788 E. Conant St., Long Beach, CA 90808 | t: 800.790.6988 | f: 888.986.5988

UF1217

2017 NEW ITEM FLYER COLLECTION



710270056255



2017 TRUCK NEW ITEM PRODUCT COLLECTION

UNITED PACIFIC INDUSTRIES



Quality / Innovation / Design

MISSION STATEMENT

Here at United Pacific, we are dedicated to providing today's drivers with innovative and exciting products that deliver exceptional performance and value. Because United Pacific's continuing success depends on our customer's satisfaction, we constantly push our designers and engineers to upgrade our facilities and processes in order to bring products of superior quality and reliability to the market. We at United Pacific promise to continue our passionate pursuit to be the first in Quality, Innovation and Design.

QUALITY

With over 30 years of experience in the automotive aftermarket industry, United Pacific Industries understands the rigors and stresses that our products are subjected to on the road. It is our mission to provide our customers with products of superior quality and reliability. In achieving this goal, United Pacific only partners with manufacturing facilities that conforms to our quality control requirements and standards. Our manufacturing partners meet or exceed ISO-9001 requirements. In addition, United Pacific's manufacturing partners must be equipped on site to perform the following quality assurance tests and maintain a track record of consistent quality and low product failure rate.

- Aging Test
- Air Tight Test
- Dust Test
- Flux Test
- Photometric Test
- Pull Force Test
- Rain Test
- Salt Spray Test
- Shock Test
- Temperature Test
- Humidity Test
- Vibration Test

Furthermore, our internal quality control structure allows us to function as the final quality control station prior to shipping. With the assistance of 3D computer technology, United Pacific can adhere to strict quality control standards during prototype creation and the production process. Our engineers and technicians perform a battery of tests to ensure that our products meet the demands of today's drivers and our goal to be first in quality.



INNOVATION

Known as the leader in innovation, United Pacific is dedicated to be the first to bring new and exciting products to the market. United Pacific's global expertise allows us to search the globe for new ideas and concepts. Not only do we search the globe for new products, United Pacific invest a significant amount of resources into our own research and development efforts. With the assistance of advance 3D scanning technology, our engineers and designers can acquire accurate and precise data in seconds. The 3D data allows United Pacific to verify designs, perform quality assurance tests, and reverse engineer with unprecedented speed and accuracy. Digital inspection contributes to the early detection of shape problems, provides rapid feedback on design, and eliminates unnecessary work in downstream processes. Our rapid prototyping facility permits us to have a concept-to-shelf time of less than 5 months. In addition, United Pacific's 3D printing capabilities permit our designers to have physical models of their design concepts in hours. The physical models allow our designers and marketing staff to evaluate and test the viability of different design ideas. Our rapid prototyping facility allow United Pacific to compress design cycles, improve manufacturing planning, shorten concept-to-shelf time, most importantly, generate new and innovative products.

DESIGN

Located near some of the nation's most progressive automotive design centers, United Pacific established the UP Design Studio in 2002 to consolidate our position as the design leader in the automotive industry. UP Design Studio utilizes the latest generation of computer aided design (CAD) and studio/graphic software. The design studio is equipped with the newest computers and rapid prototyping systems. In addition, UP Design Studio is staffed by graduates from the nation's most prestigious design colleges. Unlike our competitors, United Pacific's design and manufacturing capabilities mean that we carry more new and original items than our competitors. The establishment of the design studio will enable us to generate even more new products with significant shorter concept-to-shelf time. The reduction in development cost mean that we can develop products utilizing design based development processes. Design based product development allows United Pacific to create new product concepts based on designs incorporating driver demands and needs instead of economic considerations. United Pacific's emphasis on design distinguishes and positions us ahead of our competitors.





HOW TO ORDER

To order from United Pacific Industries, you must be an authorized dealer, distributor or OEM. If you are not authorized to stock and sell United Pacific products, you must order through an authorized dealer. Please call 800.790.6988 for more information.

CONTACT US

 8 am - 4:30 pm PST

 800.790.6988 / 562.421.3888

 888.986.5988

 sales@upauto.com

 UPauto.com/truck

 3788 E. Conant St., Long Beach, CA 90808



WARRANTY

With LED (Light Emitting Diodes) rated at 100,000 hours of operation and solid-state construction, United Pacific's LED lights are extremely reliable and durable. Purchase with confidence, United Pacific offers a complete line of LED lighting products with extended or limited lifetime warranties. Please see the warranty policy page for more details.

INVENTORY AND SHIPPING

United Pacific carries over 20,000 items in our California distribution center. No other company in the heavy duty trucking industry can match United Pacific in the variety and range of in-stock inventories. With an order fill rate of over 98.5%, United Pacific is the largest and most reliable supplier in the industry. Our shipping department ships 96.8% of all orders within 24 hours and 98.9% within 48 hours. United Pacific's vast inventory and prompt shipping has made United Pacific the only source for our customer's chrome and lighting needs.



HARD AT WORK FOR THE ENVIRONMENT



United Pacific
132,000 sq ft

Distribution Center
Long Beach, CA

100%

reduction in potable water used for landscaping

40%

reduction in total energy use due to high-efficiency mechanical and lighting systems

82%

of construction waste was diverted from landfills

LEED ACCOMPLISHMENTS

Sustainable Sites

- On-site bicycle storage, showers and changing areas for company employees.
- Preferred parking for low-emitting, fuel-efficient and carpool vehicles.
- Stormwater is infiltrated on-site and treated to remove contaminants to reduce environmental impact on local waterways.

Water Efficiency

- In addition to using reclaimed water, drought-tolerant plants and a high-efficiency irrigation system were installed to reduce the use of potable water for irrigation by 100%.

Energy and Atmosphere

- Efficient HVAC equipment and a lighting system with daylight controls reduces energy consumption by over 30%.
- Enhanced commission verifies that the building's energy and water-related systems are performing as intended by the initial design.

Indoor Environmental Quality

- Building ventilation systems was designed to provide enhanced levels of fresh outside air to building occupants.
- Interior finishes (plants, sealants, adhesives, coatings, carpet systems and composite wood) were selected with low levels of volatile organic compounds (VOCs) to reduce indoor air contamination.



TABLE OF CONTENTS

NEW ITEM SUPPLEMENT

JAN	JANUARY 2017	1
FEB	FEBRUARY 2017	9
MARCH	MARCH 2017	13
APRIL	APRIL 2017	17
MAY	MAY 2017	19
JUNE	JUNE 2017	23
JULY	JULY 2017	27
AUG	AUGUST 2017	29
SEPT	SEPTEMBER 2017	32
OCT	OCTOBER 2017	38
NOV	NOVEMBER 2017	45
DEC	DECEMBER 2017	50
INDEX	TERMS & CONDITIONS PRODUCT INDEX	56 60



NEW ITEMS

JANUARY 2017



LED Gearshift Knob - 13/15/18 Speed

DESCRIPTION

- Designer Style shift Knobs for 13/15/18 Speed Gearshift Knobs with LEDs
- CNC-Machined Grip, LEDs Available in 4 Different Colors
- Available in Chrome or Matte Black Finish

Daytona

Item #	LED	Speed	Finish	Pack
70712	Amber	13/15/18	Chrome	1 Pc./ Card
70713	Red	13/15/18	Chrome	1 Pc./ Card
70714	Blue	13/15/18	Chrome	1 Pc./ Card
70715	White	13/15/18	Chrome	1 Pc./ Card

Daytona Black

Item #	LED	Speed	Finish	Pack
70716	Amber	13/15/18	Black	1 Pc./ Card
70717	Red	13/15/18	Black	1 Pc./ Card
70718	Blue	13/15/18	Black	1 Pc./ Card
70719	White	13/15/18	Black	1 Pc./ Card

Brooklyn

Item #	LED	Speed	Finish	Pack
70720	Amber	13/15/18	Chrome	1 Pc./ Card
70721	Red	13/15/18	Chrome	1 Pc./ Card
70722	Blue	13/15/18	Chrome	1 Pc./ Card
70723	White	13/15/18	Chrome	1 Pc./ Card

Austin

Item #	LED	Speed	Finish	Pack
70724	Amber	13/15/18	Chrome	1 Pc./ Card
70725	Red	13/15/18	Chrome	1 Pc./ Card
70726	Blue	13/15/18	Chrome	1 Pc./ Card
70727	White	13/15/18	Chrome	1 Pc./ Card



LED Gearshift Knob - 9 Speed

DESCRIPTION

- Designer Style Shift Knobs for 9 Speed Gearshift Knobs with LEDs
- CNC-Machined Grip, LEDs Available in 4 Different Colors
- Available in Chrome or Matte Black Finish

Daytona

Item #	LED	Speed	Finish	Pack
70728	Amber	9	Chrome	1 Pc./ Card
70729	Red	9	Chrome	1 Pc./ Card
70730	Blue	9	Chrome	1 Pc./ Card
70731	White	9	Chrome	1 Pc./ Card

Daytona Black

Item #	LED	Speed	Finish	Pack
70732	Amber	9	Black	1 Pc./ Card
70733	Red	9	Black	1 Pc./ Card
70734	Blue	9	Black	1 Pc./ Card
70735	White	9	Black	1 Pc./ Card

Brooklyn

Item #	LED	Speed	Finish	Pack
70736	Amber	9	Chrome	1 Pc./ Card
70737	Red	9	Chrome	1 Pc./ Card
70738	Blue	9	Chrome	1 Pc./ Card
70739	White	9	Chrome	1 Pc./ Card

Austin

Item #	LED	Speed	Finish	Pack
70740	Amber	9	Chrome	1 Pc./ Card
70741	Red	9	Chrome	1 Pc./ Card
70742	Blue	9	Chrome	1 Pc./ Card
70743	White	9	Chrome	1 Pc./ Card

6 High Power LED Driving/Work Light

DESCRIPTION

- 6 High Power 3 Watt LED Work Light, Competition Series
- 10V-30V Application, 1260 Lumens, 3 Years Warranty

Item #	Description	Package	Pack
36522	6 LED Spot Light	Color Box	1 Pc./Box
36523	6 LED Flood Light	Color Box	1 Pc./Box



High Power 9005/HB3 LED Headlamp Bulb

DESCRIPTION

- 2 CREE High Power White LED
- 10W Low Beam Application, Bright 1200 Lumen Output, 6000K
- Fanless Design, Proprietary Heat Sink Dissipates Excess Heat

Item #	LEDs	Bulb Type	Package	Pack
36888	2	9005/HB3	Carded	1 Pc./Card



5" x 7" Headlight Bucket

DESCRIPTION

- Complete Inner Lamp Bucket for 5" x 7" Headlight
- Fits Peterbilt 330 1995+, Peterbilt 379 1987-2007, and Kenworth T300-T450 1993-2011
- Also Fits Many Single Headlight Vehicles

Item #	Description	Package	Pack
31444	Headlight Bucket	Boxed	1 Pc./Box



Don't Forget to Buy Bezel and Bulbs



1 LED Snap-In Indicator Light

DESCRIPTION

- Snap-In Indicator Light with 1 Super Bright LED
- Requires 1/4" Diameter Hole for installation
- Wire Length Approximately 7", Lifetime Warranty

Item #	LEDs	Lens	Package	Pack
36518B	1 Blue	Clear	Bulk	1 Pc.
36520B	1 Red	Red	Bulk	1 Pc.



Freightliner Cascadia Mesh Grille



DESCRIPTION

- Chrome Freightliner Cascadia Mesh Grille with Logo Mount
- Bug Screen Installed
- Approximately 34 1/2" L x 57 1/2" W
- Also Available without Logo Mount, Item #: 21078

Item #	Finish	OEM Number	Pack
21076	Chrome	A17-15624-002, A17-19112-000 A17-15624-003, A17-16026-000	1 Pc./Box



Freightliner "Business Class" M2 Grille



DESCRIPTION

- Freightliner "Business Class" M2 Grille without Bug Screen
- Available in Black, Chrome, and Silver Painted Finish
- Approximately 46" L x 16 1/2" W

Item #	Finish	OEM Number	Pack
21467	Black	-	1 Pc./Box
21198	Chrome	A17-14787-001 A17-14104-001	1 Pc./Box
21199	Silver	A17-14104-000 A17-14787-000	1 Pc./Box



Freightliner FL 60/70/80/106/112 Grille



DESCRIPTION

- Freightliner 60, 70, 80, 106, 112 Grille with Bug Screen
- Available in Black and Silver Painted Finish
- Approximately 44 1/2" L x 20 1/4" W

Item #	Finish	OEM Number	Pack
21468	Black	-	1 Pc./Box
21205	Chrome	A17-12935-000, A17-12935-001 A17-12935-002, A17-12935-003 A17-14768-000	1 Pc./Box



2008+ International ProStar Grille with Bug Screen



DESCRIPTION

- Grille with Bug Screen for International ProStar Trucks
- Unique Curved Grille Design
- Available in Black and Chrome

Item #	Finish	Fits	Package	Pack
21459	Black	ProStar	Boxed	1 Pc./Box
21164	Chrome	ProStar	Boxed	1 Pc./Box



International DuraStar /WorkStar Grille with Bug Screen

DESCRIPTION

- Grille with Bug Screen for International DuraStar 4100, 4200, 4300, 4400, 1300 FBC, RXT, WorkStar, 7300, 7400, 8500
- OE Style Straight Grille Design, Includes Bug Screen
- Approximately 57" L x 25" W
- Available in Black and Chrome

Item #	Finish	OEM Number	Pack
21458	Black	3564289C91, 3564289C99	1 Pc./Box
21148	Chrome	3564289C91, 3564289C99	1 Pc./Box



Chrome 2015+ Volvo VNL Front Bumper Trim

DESCRIPTION

- Chrome Plastic Front Bumper Trim for 2015+ Volvo VNL
- Sold Individually, Please Specify Driver or Passenger Side

Item #	Application	OEM Number	Pack
41697B	Driver	82741384	1 Pc./Box
41698B	Passenger	82741382	1 Pc./Box



Kenworth 2007+ T660 Bumper

DESCRIPTION

- Black Plastic Bumper for 2007+ Kenworth T660
- Sold Individually, Please Specify Driver or Passenger Side

Item #	Application	OEM Number	Pack
21088	Driver	N71-1162-611	1 Pc./Box
21089	Passenger	N71-1162-611R	1 Pc./Box



High Power Dixie Air Horn

DESCRIPTION

- Perfect Replacement or Addition to Any Car Horn, Plays the Dixie Tone
- Maintenance Free Heavy Duty 12V Air Compressor with 5 Durable ABS Trumpet Horns
- Package Includes 5 Trumpet Air Horns, 1 Air Compressor, Air Tubing, Mounting Hardwares

Item #	Description	Package	Pack
46153	Dixie Air Horn	Carded	1 Set/Card



Chrome Freightliner Fuel Cap Cover

NEW!

DESCRIPTION

- Chrome Plastic Fuel Cap Cover for Freightliner
- Fits Various Freightliner Models and Years, Double Sided Tape Mount

Item #	Description	Package	Pack
42414	Fuel Cap Cover	Carded	1 Pc./Card



Chrome Volvo & Mack DEF Cap Cover

NEW!

DESCRIPTION

- Chrome Plastic DEF Cap Cover for Volvo & Mack Trucks
- Fits Various Volvo & Mack Truck Models, Double Sided Tape Mount

Item #	Description	Package	Pack
41694	DEF Cap Cover	Carded	1 Pc./Card



Stainless Steel Shoe/Boot Scraper

NEW!

DESCRIPTION

- Shoe/Boot Scraper with 430 Stainless Steel Housing
- Mounts to Exterior Steps, Mounting Screws are Approximately 8 3/8" Apart
- Includes Mounting Gasket & Mounting Hardware

Item #	Description	Package	Pack
90050	Boot Brush	Boxed	1 Pc./Box



430 Stainless

Chrome Western Star Blank Dash Switch

NEW!

DESCRIPTION

- Chrome Plastic Blank Dash Switch for Western Star
- Fits Various Western Star Models and Years

Item #	Description	Package	Pack
40897	Blank Dash Switch	Carded	1 Pc./Card



Chrome Western Star A/C Control Knob

NEW!

DESCRIPTION

- Chrome Plastic A/C Control Knob for Western Star
- Fits Various Western Star Models and Years

Item #	Description	Package	Pack
40900	A/C Control Knob	Carded	1 Pc./Card



Chrome Skull Accent

NEW!

DESCRIPTION

- Chrome Plastic Skull Accent
- Approximately 7 1/4" L x 2 1/2" W x 1 1/4" H, Double Sided Tape Mount

Item #	Description	Package	Pack
50112	Skull Accent	Carded	1 Pc./Card

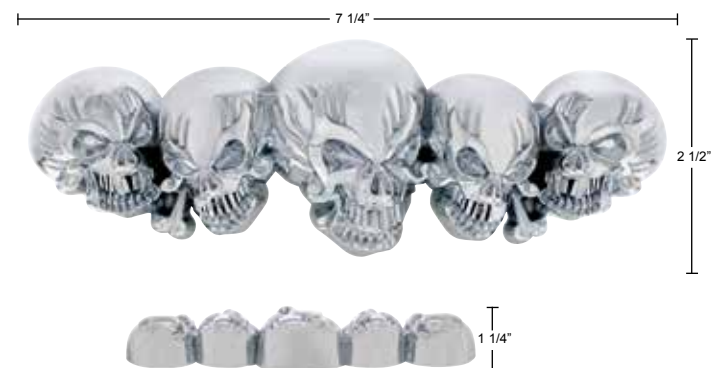



18" Steering Wheel

DESCRIPTION

- 18" Steering Wheel with Chrome Spoke
- Steering Wheel only, Hub and Horn Assembly Available Separately
- Mix and Match with United Pacific Hub and Designer Horn Bezel for a Unique and Distinctive Look

Item #	Color	Style	Package	Pack
88214	Brown	3 Spoke	Color Box	1 Pc./Box
88239	Brown	2 Spoke	Color Box	1 Pc./Box
88217	Brown	4 Spoke	Color Box	1 Pc./Box
88218	Brown	Boss	Color Box	1 Pc./Box
88219	Brown	Lady	Color Box	1 Pc./Box
88220	Brown	Flame	Color Box	1 Pc./Box
88221	Brown	GT	Color Box	1 Pc./Box
88222	Brown	Blade	Color Box	1 Pc./Box



Chrome Steering Wheel Horn Button

HOT!



Chrome Hub/Horn Assembly

DESCRIPTION

- Chrome Hub/Horn Assembly for United Pacific Steering Wheel
- Available for Various Models and Years

Item #	Description	Package	Pack
88259	Peterbilt 06+/Kenworth 03+	Color Box	1 Pc./Box
88211	PB 1998~05/KW 2001~02	Color Box	1 Pc./Box
88212	Freightliner 1989 ~July 2006	Color Box	1 Pc./Box
88213	International	Color Box	1 Pc./Box

NEW! Peterbilt 06+/Kenworth 03+



Chrome Bezel and Horn Button

HOT!



Chrome Freightliner Steering Hub

DESCRIPTION

- 72 Splines, Fits Various 2007+ Freightliner Models
- Chrome Diecast Freightliner Steering Hub for United Pacific Steering Wheels
- Mix and Match with United Pacific Steering Wheels and Designer Horn Bezel for a Unique Look

Item #	Description	Package	Pack
88238	Freightliner Steering Hub	Color Box	1 Pc./Box



33 MM x 4 3/4" Spike Nut Cover - Thread -On

NEW!

DESCRIPTION

- 33 mm Thread-On Nut Spike Cover
- Available in Chrome or Black
- All Nut Covers are Flanged to Cover Up the Flange

Item #	Description	Package	Pack
10548B	Black Spike Nut Cover	Bulk	1 Pc.
10569B	Chrome Spike Nut Cover	Bulk	1 Pc.

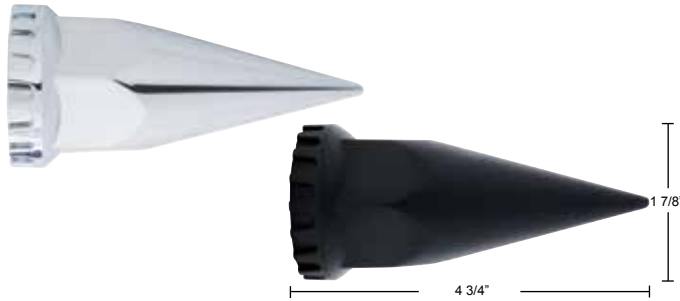

33 MM x 4 1/4" Dome Nut Cover - Thread -On

NEW!

DESCRIPTION

- 33 mm Thread-On Nut Cylinder Covers
- Fits Lug Nuts on Hub Piloted Wheels
- Available in Chrome or Black
- All Nut Covers are Flanged to Cover Up the Flange

Item #	Description	Package	Pack
10190B	Black Cylinder Nut Cover	Bulk	1 Pc.
10034B	Chrome Dome Nut Cover	Bulk	1 Pc.



33 MM x 3 3/4" Dome Nut Cover - Thread -On

NEW!

DESCRIPTION

- 33 mm Thread-On Nut Dome Covers
- Fits Lug Nuts on Hub Piloted Wheels
- Available in Chrome or Black
- All Nut Covers are Flanged to Cover Up the Flange

Item #	Description	Package	Pack
10549B	Black Dome Nut Cover	Bulk	1 Pc.
10563B	Chrome Dome Nut Cover	Bulk	1 Pc.

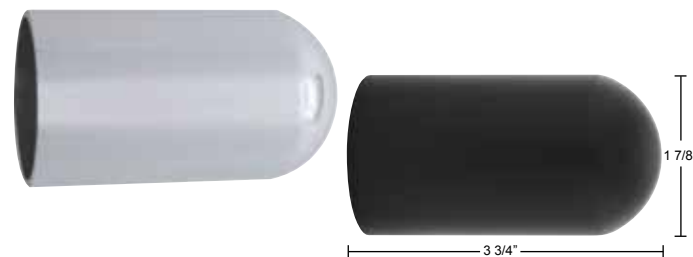

Ratchet Tie Down - S Hook

NEW!

DESCRIPTION

- Heavy Duty Ratchet Tie Down
- Zinc Plated S Hook
- Rubberized Cover Handle for Added Comfort and Grip

Item #	Description	Break Strength	Load Limits	Pack
90809	1"x15'TieDown	1,500 lbs	500 lbs.	1 Pc./Retail Pack
90810	1"x15'TieDown	1,500 lbs	500 lbs.	4Pcs./RetailPack



S Hook

Ratchet Tie Down - J Hook

HOT!

DESCRIPTION

- Heavy Duty Ratchet Tie Down
- Zinc Plated Double J Hook
- Rubberized Cover Handle for Added Comfort and Grip for Item # 90800 and 90801

Item #	Description	Break Strength	Load Limits	Pack
90800	1.5"x15'TieDown	6,600 lbs	2,200 lbs.	1 Pc./Retail Pack
90801	2"x27'TieDown	10,000 lbs	3,333 lbs.	1 Pc./Retail Pack
90802	3"x27'TieDown	15,000 lbs	5,000 lbs.	1 Pc./ Bulk
90803	4"x30'TieDown	16,200 lbs	5,400 lbs.	1 Pc./ Bulk



Double J Hook

Ratchet Tie Down - Flat Hook

NEW!

DESCRIPTION

- Heavy Duty Ratchet Tie Down
- Zinc Plated Flat Hook

Item #	Description	Break Strength	Load Limits	Pack
90808	4"x30'TieDown	16,200 lbs	5,400Lbs	1 Pc./ Bulk

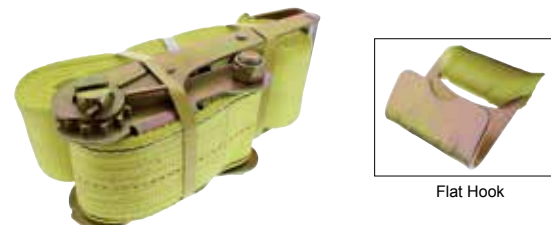

Flat Hook

Toyota Coaster 16" Wheel Cover

DESCRIPTION

- Stainless Steel Wheel Cover for Toyota Coaster
- 1 Set Includes 2 Front Axle Covers, 2 Rear Axle Covers, and 20 Nut Covers

Item #	Description	Package	Pack
20102	Toyota Coaster Wheel Cover	Boxed	1 Set/Box



Chrome Turn Signal Switch with 4-Way Hazard Function

DESCRIPTION

- Die Cast Metal and Chrome Plastic Housing
- Clamps on Steering Column
- 4 Way Hazard Switch
- Lighted Direction Indicators

Item #	Description	Package	Pack
110307	Turn Signal Switch	Color Box	1 Pc./Box



COMPETITION
SERIES

Chrome Interior Rear View Mirror with Glue-On Mount

DESCRIPTION

- Perfect Mirror for Hot Rods, Street Rods
- Easy Installation, Simply Glue-On to Windshield Glass
- Recommended Adhesive: Loctite 37438, Permatex 81840, 3M 08752

Item #	Description	Package	Pack
70801	Rectangular Mirror	Boxed	1 Pc./Box
70802	Oval Mirror	Boxed	1 Pc./Box



2000 - 2015 Ford F-650/F-750 Headlight Assembly

DESCRIPTION

- 5" x 7" Headlight Assembly for 2000-2015 Ford F-650/F-750
- Sold Individually, Please Specify Driver or Passenger Side
- 1 Year Warranty

Item #	Description	OEM Number	Pack
31171	Driver	E99Z 13118 A+F3UZ 13007	1 Pc./Box
31172	Passenger	E99Z 13119 A+F3UZ 13007	1 Pc./Box



UN161225



NEW ITEMS

FEBRUARY 2017

DUAL COLOR



3 LED Dual Color Mini Clearance/Marker Light

DESCRIPTION

- 3 LED Dual Color Mini Clearance/Marker Light with Stainless Steel Bezel
- Requires a 3/4" Opening, 3 Wire Hardwired, Rubber Grommet Included



Item #	Primary LED	Secondary LED	Lens	Pack
36838	Amber	Red	Clear	1 Pc./Card
36839	Amber	White	Clear	1 Pc./Card
36840	Amber	Blue	Clear	1 Pc./Card
36841	Red	White	Clear	1 Pc./Card
36842	Red	Blue	Clear	1 Pc./Card



9 LED Square Wide Angle Driving/Work Light

DESCRIPTION

- 9 LED Square Work Light, Wide Angle Design
- 12V-36V Application, 2160 Lumens, 3 Years Warranty

Item #	Description	Package	Pack
36514	9 LED Flood Light	Carded	1 Pc./Card
36514B	9 LED Flood Light	Bulk	1 Pc.

Color Retail Packaging



High Power Double Row LED Light Bar

DESCRIPTION

- 3W High Power "Cree" LED, Double Row LED light Bar
- 3 1/8" Tall x 3 1/2" Wide, Light is 4 3/4" Tall with Mounting Bracket
- Available in 3 Different Lengths, Heavy Duty Aluminum Housing, **3 Year Warranty**

Item #	LEDs	Lumens	Length	Pack
36781	12	2640 lm	7 1/2"	1 Pc./Box
36782	24	5280 lm	13 1/2"	1 Pc./Box
36783	40	8800 lm	21 1/2"	1 Pc./Box



8 LED Oval Wide Angle Driving/Work Light

DESCRIPTION

- 8 LED Oval Work Light, Wide Angle Design
- 12V-36V Application, 1920 Lumens, 3 Years Warranty

Item #	Description	Package	Pack
36515	8 LED Flood Light	Carded	1 Pc./Card
36515B	8 LED Flood Light	Bulk	1 Pc.

9 LED Dual Function "GLO" Grakon 1000 Style Cab Light Kit with Visor



DESCRIPTION

- Available in Amber or Clear Lens with Watermelon Lens
- Chrome Plastic Cab Light Housing Available Separately, Item # 30608B
- Includes Hardware and Gasket, Hard Wired with Three .180 Bullet Plugs

Item #	LEDs	Lens	Style	Pack
36749	9 Amber	Amber	GLO	1 Kit/Box
36750	9 Amber	Clear	GLO	1 Kit/Box



GloLight.

Dual Function

19 LED Grakon 1000 Style Cab Light Kit with Visor



DESCRIPTION

- Available in Amber or Clear Lens with Watermelon, Reflector, or Beehive Lens
- Chrome Plastic Cab Light Housing Available Separately, Item # 30608B
- Includes Hardware and Gasket, Hard Wired with Two .180 Bullet Plugs

Item #	LEDs	Lens	Style	Pack
36751	19 Amber	Amber	Watermelon	1 Kit/Box
36752	19 Amber	Clear	Watermelon	1 Kit/Box
36753	19 Amber	Amber	Reflector	1 Kit/Box
36754	19 Amber	Clear	Reflector	1 Kit/Box
36755	19 Amber	Amber	Beehive	1 Kit/Box
36756	19 Amber	Clear	Beehive	1 Kit/Box



Chrome Cab Light Housing with Visor



DESCRIPTION

- Chrome Plastic Cab Light Housing with Visor
- Includes Hardware and Gasket

Item #	Description	Package	Pack
30608B	Housing with Visor	Boxed	1 Pc./Box

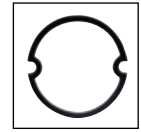

COMPETITION SERIES

18" Carbon Black Woodgrain Steering Wheel



DESCRIPTION

- 18" Diameter with a Deep Luxurious Carbon-Black Woodgrain Finish
- Steering Wheel Only, Hub and Horn Assembly Available Separately

Item #	Description	Package	Pack
88237	Carbon 4 Spoke Steering	Color Box	1 Pc./Box



18" Steering Wheel Cover



DESCRIPTION

- 18" Engineered Leather Steering Wheel Covers
- Unique Euro - Tone Two Color Design

Item #	Description	Package	Pack
70405	Black/Blue	Carded	1 Pc./Card
70406	Black/Red	Carded	1 Pc./Card



Freightliner Cascadia 2008+ Cowl Panel

DESCRIPTION

- Cowl Panel for Freightliner Cascadia
- Sold Individually, Please Specify Driver or Passenger Side

Item #	Application	OEM Number	Pack
20706	Driver	A18-64907-002	1 Pc./Box
20707	Passenger	A18-64907-003	1 Pc./Box



Volvo VNL & VN 2004 - 2014 Center Bumper

DESCRIPTION

- Black Plastic Center Bumper for 2004-2014 Volvo VNL and VN

Item #	Finish	OEM Number	Pack
20899	Black	20470446	1 Pc./Box



Chrome 2008 - 2016 Kenworth T660 Grille Surround

DESCRIPTION

- Chrome Plastic 2008 - 2016 Kenworth T660 Grille Surround

Item #	Finish	OEM Number	Pack
21087	Chrome	L29-1174-100	1 Pc./Box



Chrome Peterbilt 1987 - 2005 Exterior Sleeper Door Handle

DESCRIPTION

- Exterior Sleeper Door Handle for 1987-2005 Peterbilt
- Sold Individually, Please Specify Driver or Passenger Side

Item #	Application	OEM Number	Pack
42783	Driver	29-03610L	1 Pc./Box
42770	Passenger	29-03610R	1 Pc./Box

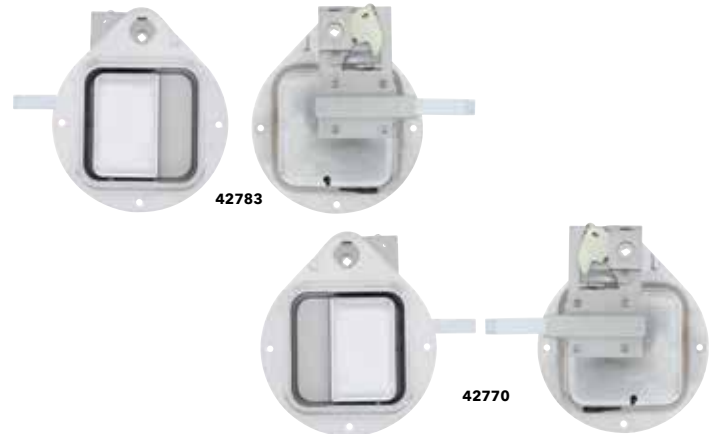

Chrome Peterbilt Skull Emblem

DESCRIPTION

- Chrome Diecast 7 7/8" x 3 1/4" Peterbilt Skull Emblem,
- Same Size as OEM Emblem, 3D Skull Design
- Mounting Studs Are 6 1/4" Apart, Speed Nuts Included

Item #	Description	Package	Pack
10963	Skull Emblem	Carded	1 Pc./Card



33 MM x 4" Thread-On Nut Cover with Flange

DESCRIPTION

- 33mm Thread-on Nut Cover with Flange, Available in Chrome or Black
- All Nut Covers are Flanged to Cover Up the Flange

Item #	Finish	Height	Flange	Pack
10551B	Black	4"	Yes	Bulk=1 Pc.
10572B	Chrome	4"	Yes	Bulk=1 Pc.



33 MM x 3 3/4" Thread-On Nut Cover with Flange

DESCRIPTION

- Chrome Plated 33mm Thread-on Nut Cover
- All Nut Covers are Flanged to Cover Up the Flange

Item #	Finish	Height	Flange	Pack
10562B	Chrome	3 3/4"	Yes	Bulk=1 Pc.

33 MM x 2 3/4" Thread-On Nut Cover with Flange

DESCRIPTION

- 33mm Thread-on Nut Cover with Flange, Available in Chrome or Black
- All Nut Covers are Flanged to Cover Up the Flange

Item #	Finish	Height	Flange	Pack
10552B	Black	2 3/4"	Yes	Bulk=1 Pc.
10064B	Chrome	2 3/4"	Yes	Bulk=1 Pc.



LED Headlight PWM Anti Flicker Module & Adaptor

DESCRIPTION

- Works With Most Vehicles Using Pulse Width Modulated Electrical System, Such as 2007-Present Jeep JK
- Eliminates Flicker on LED Headlamps
- Adapts Common H13 Plug to H4 Plug Used by Most LED Headlights

Item #	Description	Package	Pack
34217B	Anti Flicker Adaptor	Bulk	1 Pc.

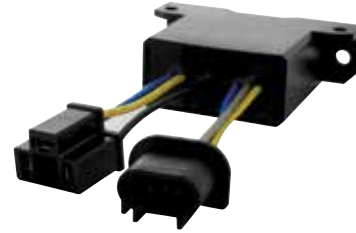

Foliage Camo License Frame

DESCRIPTION

- High Quality Camouflage Printing on Metal License Frame

Item #	Description	Package	Pack
50047	Foliage Camo License Frame	Carded	1 Pc./Card



Motorcycle Rubber Grip Set

DESCRIPTION

- High Quality Molded Rubber Provides Comfortable Grip
- Old School Dirt Track Look in 4 Colors, Sold in Pairs
- Available for 7/8" or 1" Handlebar, Twist Grip Side has Larger ID

Item #	Size	Color	Pack
52000B	1"1/1-1/8" (25/28mm)	Black	1 Pair/Color Box
52001B	1"1/1-1/8" (25/28mm)	Red	1 Pair/Color Box
52002B	1"1/1-1/8" (25/28mm)	White	1 Pair/Color Box
52003B	1"1/1-1/8" (25/28mm)	Natural	1 Pair/Color Box
52004B	7/8"1" (22/25mm)	Black	1 Pair/Color Box
52005B	7/8"1" (22/25mm)	Red	1 Pair/Color Box
52006B	7/8"1" (22/25mm)	White	1 Pair/Color Box
52007B	7/8"1" (22/25mm)	Natural	1 Pair/Color Box





NEW ITEMS

MARCH 2017



Item # 70664B

Item # 70665B

LED Light Not Included

Chrome LED Gearshift Mounting Adaptor - Vertical

DESCRIPTION

- Chrome Diecast LED Gearshift Mounting Adaptor, Vertical Mount
- Fits with 13/18 and 9 Speed Gearshift Knobs
- LED Light Available Separately, Item # 36897-98, 36905-36908
- Patent Pending

Item #	Description	Speed	Pack
70664B	1" LED Top Mount Adaptor	13/18	1 Pc.
70665B	1" LED Top Mount Adaptor	9	1 Pc.

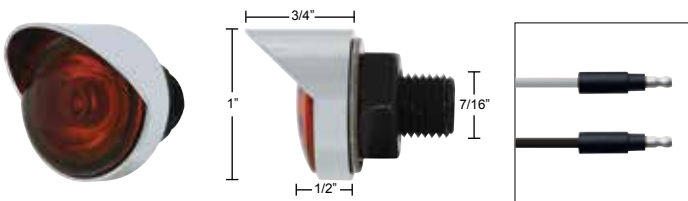

3 High Power LED 1" Clearance / Marker Light with Visor

DESCRIPTION

- 3 High Power LED 1" Clearance/Marker Light with Chrome Plastic Visor
- Available in Amber, Blue, Red, or White LED with Colored or Clear Lens

Item #	LEDs	Lens	Package	Pack
36897	3 Amber	Amber	Carded	1 Pc./Card
36898	3 Red	Red	Carded	1 Pc./Card
36905	3 Amber	Clear	Carded	1 Pc./Card
36906	3 Blue	Clear	Carded	1 Pc./Card
36907	3 Red	Clear	Carded	1 Pc./Card
36908	3 White	Clear	Carded	1 Pc./Card



New Retail Packaging!



Chrome Designer Gearshift Knob

DESCRIPTION

- Chrome Designer Gearshift Knobs, CNC-Machined Grip
- Fits 13/18 Speed Gearshift Knob
- Patent Pending

Vertical Gearshift Knob

Item #	Description	Package	Pack
70609	"Daytona" Gearshift Knob	Carded	1 Pc./Card
70610	"Vegas" Gearshift Knob	Carded	1 Pc./Card
70624	"Dallas" Gearshift Knob	Carded	1 Pc./Card
70628	"Talladega" Gearshift Knob	Carded	1 Pc./Card
70649	"Brooklyn" Gearshift Knob	Carded	1 Pc./Card
70650	"Austin" Gearshift Knob	Carded	1 Pc./Card

Horizontal Gearshift Knob

Item #	Description	Package	Pack
70607	"Daytona" Gearshift Knob	Carded	1 Pc./Card
70608	"Vegas" Gearshift Knob	Carded	1 Pc./Card
70623	"Dallas" Gearshift Knob	Carded	1 Pc./Card
70627	"Talladega" Gearshift Knob	Carded	1 Pc./Card
70647	"Brooklyn" Gearshift Knob	Carded	1 Pc./Card
70648	"Austin" Gearshift Knob	Carded	1 Pc./Card
70588	Black "Daytona" Gearshift Knob	Carded	1 Pc./Card

Item # 70604B



Item # 70600B



10 LED 9" Split Turn Function Light Bar - Chrome Bezel

DESCRIPTION

- 10 LED 9" Split Turn Function Light Bar with Chrome Plastic Bezel, 4 Wire Hardwired
- Mounting Screws Can Be Move to Accommodate Mounting Distance from 4 1/2"- 7 3/8" Apart, Stainless Steel Mounting Hardware Included
- 9" Chrome Plastic Light Bar Bezel Available Separately: Item # 30932B

Item #	LEDs	Lens	Package	Pack
32778	10 Red	Red	Carded	1 Pc./Card

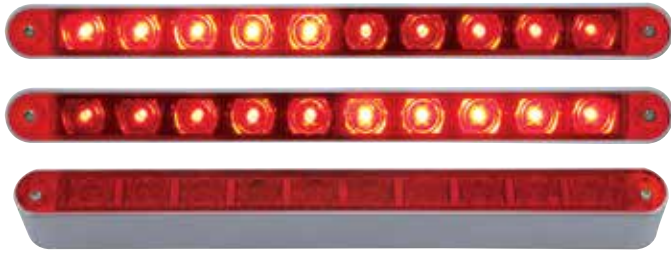

10 LED 9" Split Turn Function Light Bar

DESCRIPTION

- 10 LED 9" S/T/T/ Light Bar with Split Turn Function
- 4 Wire Hardwired, Approximate Size: 9" L x 5/8" W
- Mounting Hole Approximately 8 1/2" Apart, **Lifetime Warranty**

Item #	LEDs	Lens	Package	Pack
36827B	10 Red	Red	Bulk	1 Pc.

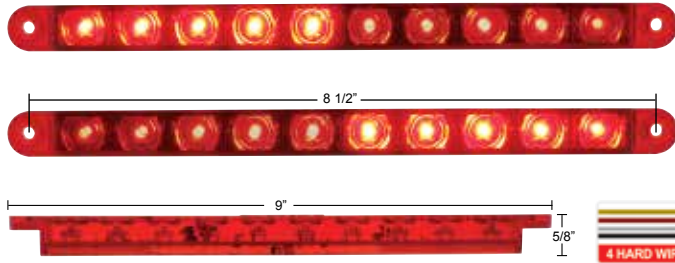

Chrome Deluxe LED License Plate Frame - Split Turn Function

DESCRIPTION

- License Frame with 10 LED 9" Split Turn Function Light Bar
- 10 Red LED with Red Lens
- New Deluxe Vintage Design
- Chrome Deluxe License Plate Frame Available Separately: Item # 50015B

Item #	LEDs	Lens	Package	Pack
39397	10 Red	Red	Carded	1 Pc./Card



17 High Power LED 7" Spot/Off Road Light

NEW!

DESCRIPTION

- 17 High Power 7" Spot/Off-Road Light, Diecast Aluminum Housing
- 10V-30V, 3100 Lumens, **3 Year Warranty**

Item #	LEDs	Lumens	Voltage	Pack
36516	17	3100	10V - 30V	1 Pc./Box



High Power Double Row LED Light Bar

HOT!

DESCRIPTION

- 1.5W High Power LED, Double Row LED light Bar
- 3 1/4" Tall x 2 1/8" Wide, Light is 5 1/8" Tall with Mounting Bracket
- Heavy Duty Aluminum Housing, **3 Year Warranty**

Item #	LEDs	Lumens	Length	Pack
36646	24	2160 lm	7 1/4"	1 Pc./Box
36647	48	4320 lm	13 1/4"	1 Pc./Box
36648	80	7200 lm	21 1/4"	1 Pc./Box
36649	120	10800 lm	30 1/2"	1 Pc./Box

Color Retail Packaging



1 LED Snap-In Indicator Light

NEW!

DESCRIPTION

- Snap-In Indicator Light with 1 Super Bright LED
- Requires 1/4" Diameter Hole for Installation
- 2 Wire Hardwired, Wire Length Approximately 7"

Item #	LEDs	Lens	Package	Pack
36517B	1 Amber	Amber	Bulk	1 Pc.
36518B	1 Blue	Clear	Bulk	1 Pc.
36519B	1 Green	Green	Bulk	1 Pc.
36520B	1 Red	Red	Bulk	1 Pc.
36521B	1 White	Clear	Bulk	1 Pc.



International DuraStar / WorkStar Grille with Curved Grille



DESCRIPTION

- Grille for International DuraStar 4100, 4200, 4300, 4400, 1300 FBC, RXT, WorkStar, 7300, 7400, 8500, Available in Black and Chrome
- Unique Curved Grille Design

Item #	Finish	OEM #	Bug Screen	Pack
21457	Black	3551015C98	Yes	1 Pc./Box
21206	Chrome	3551015C98	No	1 Pc./Box



Chrome Peterbilt Texas Emblem



DESCRIPTION

- Chrome Diecast Peterbilt Texas Emblem,
- Same Size as OEM Emblem, 8" x 3 1/4"
- Mounting Studs Are 6 1/4" Apart, Speed Nuts Included

Item #	Description	Package	Pack
10934	Texas Emblem	Carded	1 Pc./Card



Chrome Freightliner Cascadia Storage Door Cover



DESCRIPTION

- Chrome Plastic Storage Door Cover for Freightliner Cascadia
- Easy Installation, Double Sided Tape Included

Item #	Description	Fits	Pack
42343	13 1/2" Upper Center Cover	T155, 415277	1 Pc./Card
42344	12 3/4" Upper L or R Cover	T155, 415278	1 Pc./Card

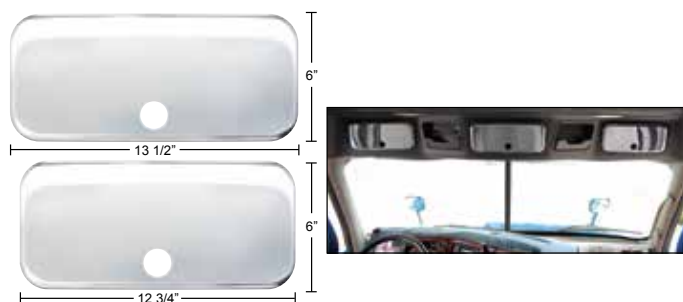

Chrome 2005+ Freightliner Mirror Cover Plugs



DESCRIPTION

- Chrome Mirror Cover Plugs for 2005+ Freightliner
- 2 Right and 2 Left Plugs, Plugs for UP Item # 42060

Item #	Description	Package	Pack
42070	Mirror Cover Plugs	Carded	2 Sets/Card

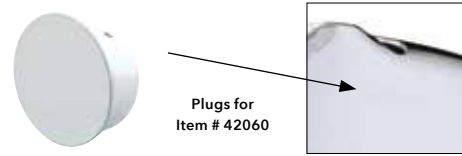

Black Shifter Shaft Extender



DESCRIPTION

- Black Shifter Shaft Extension in 12" or 18", 3/4" Diameter
- Thread On (1/2" - 13 UNC Thread), Thread 1" Long

Item #	Length	Description	Pack
21796	12"	Shaft Extender	1 Pc./Card
21797	18"	Shaft Extender	1 Pc./Card



Chrome Mack Rocker Switch Trim



DESCRIPTION

- Chrome Plastic Switch for Mack Trucks

Item #	Description	Package	Pack
41851	Rocker Switch Trim	Carded	2 Pcs./Card



Blue Tiger Elite Premium Bluetooth Headset



DESCRIPTION

- 34 Hours of Talk Time, 600 Hours of Standby Time
- Elite Bluetooth Headset with Hi-Fi Speaker, Bluetooth 4.0
- Multimedia Playback- Listen to Music, Podcasts and More
- Noise-Canceling Technology Allows You to Focus More Easily
- Includes Wall Charger and Car/Truck Cigarette Lighter Charger

Item #	Description	Package	Pack
95000	Black Headset	Boxed	1 Pc./Box
95001	Camo Headset	Boxed	1 Pc./Box



Chrome 9/16" x 11/16" Flat Top Nut Cover - Push-On



DESCRIPTION

- Chrome Plastic Flat Top Push-On Nut Cover for Hex Nuts and Bolts

Item #	Description	Package	Pack
10752	Flat Top Nut Cover	Carded	10 Pcs./Card
10752B	Flat Top Nut Cover	Bulk	1 Pc



Aluminum Straight Conspicuity Reflector Top Flap Plates



DESCRIPTION

- Aluminum Straight Conspicuity Reflector Top Flap Plate, Sold By Pairs

Item #	Description	Package	Pack
11137B	Reflector Top Flap Plates	Bulk	1 Pair

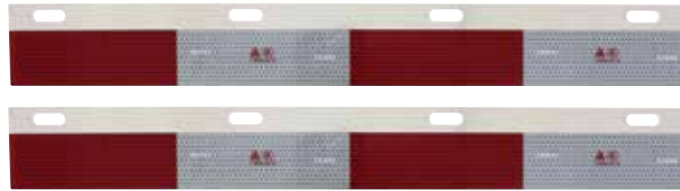

Chrome Aluminum Interior Rear View Mirror - Screw-On Mount



DESCRIPTION

- Perfect Mirror for Hot Rods, Street Rods
- Easy Installation, Mounts At Any Angle With the Fully Adjustable Mirror Arm Base

Item #	Description	Package	Pack
70803	Rectangular Mirror	Boxed	1 Pc./Box
70804	Oval Mirror	Boxed	1 Pc./Box



2 - Pack Black Metal License Frame Kit



DESCRIPTION

- Kit Includes 2 License Plate Frames, 4 Screws & 4 Screw Caps
- Durable Black Powder Coated Finish on Metal Die-Cast Wide Bottom License Frames

Item #	Description	Package	Pack
49999	Black License Plate Frames	Carded	1Kit/Card



Skull Motorcycle License Frame



DESCRIPTION

- Zinc Diecast Skull Motorcycle License Frame, Universal Fit

Item #	Description	Finish	Pack
50113	Skull License Frame	Black	1 Pc./Card
50065	Skull License Frame	Chrome	1 Pc./Card



Black Motorcycle License Frame



DESCRIPTION

- Black Zinc Die-Cast Motorcycle License Frame

Item #	Description	Package	Pack
50109	Black License Frame	Carded	1 Pc./Card



Stainless Steel Locking Tie



DESCRIPTION

- 304 Grade Stainless Steel Never Rusts
- Withstands Temperatures Up to 2,500 Degrees
- Quick Easy Ball-Bearing Locking Mechanism Holds Tight
- Perfect for Securing Exhaust Wrap on Headers & Pipes
- Excellent Upgrade for Electrical Wire Tie Applications

Item #	Description	Package	Pack
90322	8" Locking Tie	Carded	8 Pcs./Card
90323	14" Locking Tie	Carded	4 Pcs./Card





NEW ITEMS

APRIL 2017

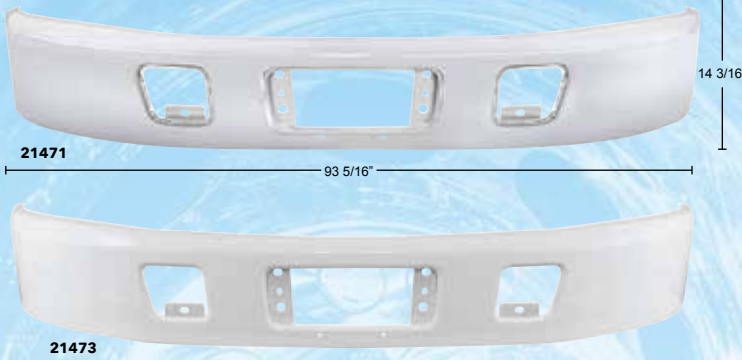

2005+ Hino 238/258/268/338 Bumper

DESCRIPTION

- Bumper for 2005 and Newer Hino 238/258/26/338
- Available in Chrome, Black and White Finish
- Approximately 93 5/16" L x 14 3/16" W, Oversize Freight Policy

Item #	Finish	OEM Number	Pack
21471	Chrome	52101E0A91	1 Pc./Box
21472	Black		1 Pc./Box
21473	White		1 Pc./Box

Freightliner FL 60/70/80/106/112 Grille



DESCRIPTION

- Freightliner 60, 70, 80, 106, 112 Grille with Bug Screen
- Available in Chrome, Black and Silver Painted Finish
- Approximately 44 1/2" L x 20 1/4" W

Item #	Finish	OEM Number	Pack
21147	Chrome	A17-12935-000, A17-12935-001	1 Pc./Box
21468	Black	A17-12935-002, A17-12935-003	1 Pc./Box
21205	Silver	A17-14768-000	1 Pc./Box



21147

21468



21205

Chrome 1988 - 2008 Mack CH600 Headlight Bezel



DESCRIPTION

- Chrome Plastic Headlight Bezel for 1988-2008 Mack CH600
- Sold Each, Fits Driver and Passenger Side

Item #	Description	OEM Number	Pack
31162	Headlight Bezel	731395475	1 Pc./Box



Stainless Steel Guide Headlight Visor



DESCRIPTION

- Great Classic Look & Upgrade for All Guide Style 7" Headlights
- Visor Has Built-In Bulb Retailer Ring for Easy Installation
- Polished 430 Stainless Steel, Sold Each

Item #	Description	Package	Pack
31519	Guide Headlight Visor	Bulk	1 Pc.



33 MM x 3 7/8" Bullet Nut Cover - Thread - On

DESCRIPTION

- Durable High Quality Chrome Plated Plastic or Molded Black Finish
- Threads-On to 33mm Wheel Studs for a Secure Fit
- Completely Covers the Lug Nut & Lug Nut Flange Washer

Item #	Finish	Height	Flange	Pack
10550B	Black	3 7/8"	No	Bulk=1 Pc.
10564B	Chrome	3 7/8"	No	Bulk=1 Pc.

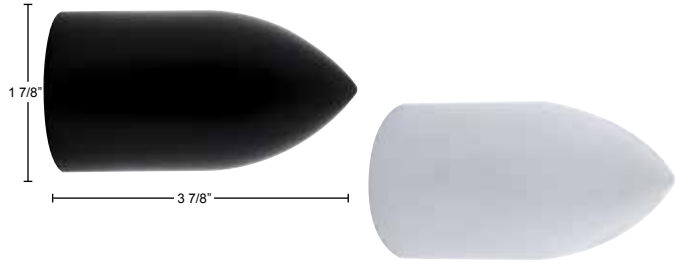

NEW!

2 - Pack Metal License Frame Kit

DESCRIPTION

- Kit Includes 2 License Plate Frames, 4 Screws & 4 Screw Caps
- Available with Chrome Steel or Black Powder Coated Finish

Item #	Description	Package	Pack
49998	Chrome Frames	Carded	1Kit/Card
49999	Black Frames	Carded	1Kit/Card



NEW!

33 MM x 3 3/4" Concave Top Nut Cover - Thread - On

DESCRIPTION

- Durable High Quality Chrome Plated Plastic
- Threads-On to 33mm Wheel Studs for a Secure Fit
- Completely Covers the Lug Nut & Lug Nut Flange Washer

Item #	Finish	Height	Flange	Pack
10300B	Chrome	3 3/4"	No	Bulk=1 Pc.



NEW!

Trucker Girl Key Chain / Bottle Opener

DESCRIPTION

- High Quality Aluminum with Polished & Clear Anodized Finish
- Includes Standard Key Ring and Attractive Retail Card Packaging

Item #	Description	Package	Pack
99098	Trucker Girl Bottle Opener	Carded	1 Pc./Card

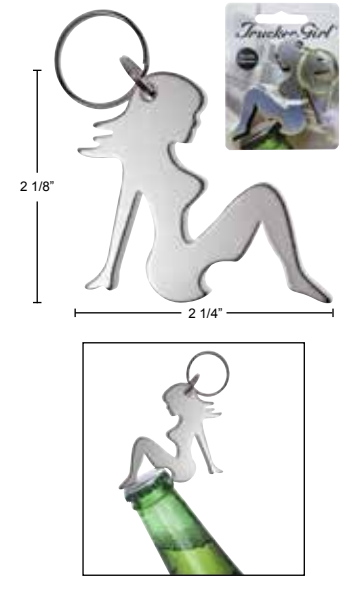

NEW!

Chrome Universal Front Hub Cap with Hubometer Hole

DESCRIPTION

- Chrome Steel with Notched 7/16" Wide Lip
- Fits 4, 5 or 6 Notched Hubs, May Not Fit Some 4-Even Notched Hubs
- Includes Four Attaching Clips
- Hubometer Hole Is 4.80" Diameter
- Also Known As Hubometer/Hubodometer

Item #	Lip	Material	Package	Pack
10112	7/16"	Chrome	Bulk	1 Pc.



NEW!

United Pacific LED "Mirage" Light Display

DESCRIPTION

- United Pacific LED "Mirage" Light Display
- Multi Functional Control Allows Drivers to See the Lights in Different Modes of Operations

Item #	Description	Package	Pack
99087	"Mirage" Light Display	Boxed	1 Pc./Box





NEW ITEMS

MAY 2017

"DOUBLE FURY" 2 COLOR LEDS



14 LED 4" S/T/T & P/T/C Light with Dual Color LEDs

DESCRIPTION

- 14 LED 4" S/T/T & P/T/C Light with Dual Color LEDs
- 3 Contact Female Plug with An Additional Yellow Wire to Activate the Secondary Function/Color
- DOT/SAE Approved, Secondary Color for Auxiliary Use Only
- Recommended Plug: Item # 34212/34216, [Lifetime Warranty](#)

Item #	Primary Color	Secondary Color	Lens	Pack
36528	Red	Amber	Clear	1 Pc./Card
36529	Red	Blue	Clear	1 Pc./Card
36530	Red	White	Clear	1 Pc./Card
36531	Amber	Blue	Clear	1 Pc./Card
36532	Amber	White	Clear	1 Pc./Card

12 LED Fender Signal Light for Peterbilt 579/587

DESCRIPTION

- 12 LED Fender Signal Light for Peterbilt 579/587
- Unique Light Bar Design, Available in Amber or Clear Lens
- Sold Individually, Please Specify Driver or Passenger Side, [Lifetime Warranty](#)



Item #	Application	OEM #	Lens	Pack
36828	Driver	P54-1212-100	Amber	1 Pc./Card
36829	Passenger	P54-1212-100R	Amber	1 Pc./Card
36830	Driver	P54-1212-100	Clear	1 Pc./Card
36831	Passenger	P54-1212-100R	Clear	1 Pc./Card



Kit (Item # 36832BRK) Includes



30 LED 4" S/T/T Light Kit

DESCRIPTION

- 30 LED 4" Round S/T/T Light Kit
- Kit Includes Light, Grommet (Item # 31515) and Plug (Item # 34212)
- Recommended Plug: Item # 34212, [Lifetime Warranty](#)

Item #	LEDs	Lens	Package	Pack
36832BRK	30 Red	Red	Bag	1 Kit

2004+ Volvo VN / VNL Projection Headlight

DESCRIPTION

- Volvo VN / VNL 2004+ and Newer Projection Headlight with LED Position Light Bar
- Available in Crystal or Blackout Design
- DOT/SAE Approved
- Sold Individually, Please Specify Driver or Passenger Side, **1 Year Warranty**

Technical Specification

Low Beam Application
12V DC Input
4.58 Amps / 55 Watt
FMVSS 571.108

High Beam Application
12V DC Input
4.58 Amps / 55 Watt
FMVSS 571.108

Item #	Application	Description	Pack
31445	Driver	Chrome	1 Pc./Box
31446	Passenger	Chrome	1 Pc./Box
31447	Driver	Blackout	1 Pc./Box
31448	Passenger	Blackout	1 Pc./Box



31447



31446



Connect to Original OE Plug



NEW!

17 LED Tail Light Assembly with Flush Mount Bezel

DESCRIPTION

- 17 Super Bright Red LEDs with Flush Mount Bezel
- Light Is 3 3/4" Dia. and 3/4" Tall
- Mounting Stud Are Approximately 3 7/16" Apart
- Includes Installation Hardwares and Mounting Pad

NEW!

Item #	Style	LEDs	Lens	Pack
110406	Chrome	17	Red	1 Pc./Card
110407	Chrome Grille	17	Red	1 Pc./Card
110409	Black Grille	17	Red	1 Pc./Card



110406



110407



110409

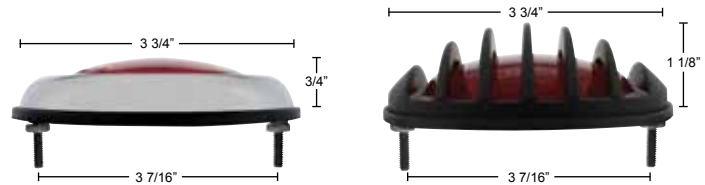

Mack CX Grille with Bug Screen

DESCRIPTION

- Mack CX Grille with Bug Screen
- Available in Chrome and Black Finish
- Approximately 27" L x 41" W

NEW!

Item #	Finish	OEM Number	Pack
21466	Black	6MF580M	1 Pc./Box
21204	Chrome		1 Pc./Box

New All Black



21466



21204



NEW!

REAR AXLE COVER KIT x 4

Item # 10275



FRONT AXLE COVER KIT x 2

Item # 10252



NUT COVER TOOL

Item # 10259

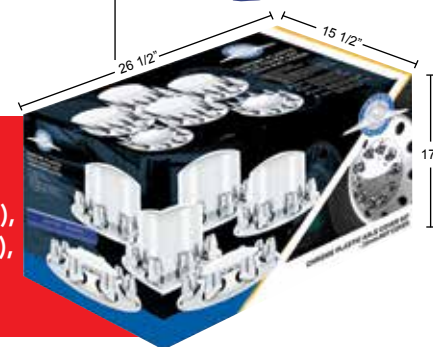

Complete Combo Kit in 1 Color Retail Box. Front Axle Cover Kit (2 Each), Rear Axle Cover Kit (4 Each), And Nut Cover Tool (1 Pc.), All In 1 Color Retail Box

Axle Cover Combo Kit with Spike Nut Cover - 33mm

DESCRIPTION

- Chrome Plastic Axle Cover Combo Kit
- Includes Everything You Need to Dress Up Your Wheels
- Kit Includes:
 - Chrome Plastic Front Axle Cover x 2
 - Chrome Plastic Rear Axle Cover x 4
 - Chrome Plastic 33mm Thread-On Nut Cover x 60
 - Nut Cover Tool x 1

Item #	Style	Size	Package	Pack
10307	Dome	33mm Thread-On	Color Box	1 Kit/Box

Chrome Mack A/C Control Knob

DESCRIPTION

- Chrome Plastic A/C Control Knob for Mack Trucks
- Fits Various Mack Models And Years

NEW!

Item #	Description	Package	Pack
41850	A/C Control Knob	Carded	1 Pc./Card



Chrome Freightliner Cascadia Hazard Trim

DESCRIPTION

- Chrome Plastic Hazard Trim for Freightliner
- Fits Freightliner Cascadia Model

NEW!

Item #	Description	Package	Pack
42416	Hazard Trim	Carded	1 Pc./Card



Chrome Peterbilt U.S. Emblem

DESCRIPTION

- Chrome Diecast Peterbilt Flag Emblem
- Same Size As OEM Emblem, 8" x 3 1/4"
- Mounting Studs Are 6 1/4" Apart, Speed Nuts Included

Item #	Description	Package	Pack
10945	US Flag Emblem	Carded	1 Pc./Card



Chrome Peterbilt Texas Emblem

DESCRIPTION

- Chrome Diecast Peterbilt Texas Emblem
- Same Size as OEM Emblem, 8" x 3 1/4"
- Mounting Studs Are 6 1/4" Apart, Speed Nuts Included

Item #	Description	Package	Pack
10934	Texas Emblem	Carded	1 Pc./Card



Chrome Peterbilt Skull Emblem

DESCRIPTION

- Chrome Diecast Peterbilt Skull Emblem,
- Same Size as OEM Emblem, 3D Skull Design, 8" x 3 1/4"
- Mounting Studs Are 6 1/4" Apart, Speed Nuts Included

Item #	Description	Package	Pack
10963	Skull Emblem	Carded	1 Pc./Card



Chrome Freightliner Emblem Blank

DESCRIPTION

- Chrome Plastic Freightliner Blank Emblem
- Fits Various Freightliner Models and Years

Item #	Description	Package	Pack
21077B	Emblem Blank	Boxed	1 Pc./Box

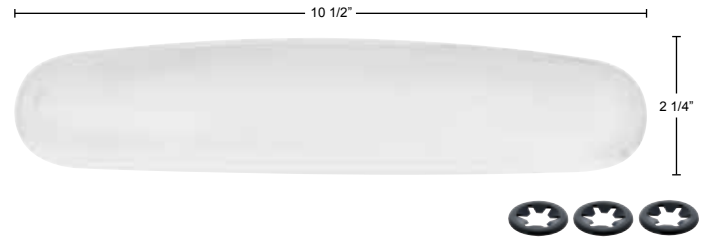

U.S. Military Adhesive Metal Medallion - 1 3/4"

DESCRIPTION

- 1 3/4" Round U.S. Military Adhesive Metal Medallion
- Minted in A Brass Alloy and Finished in Bronze
- Officially Licensed Product

Item #	Description	Package	Pack
22974	U.S. Air Force Medallion	Carded	1 Pc./Card
22975	U.S. Army Medallion	Carded	1 Pc./Card
22976	U.S. Navy Medallion	Carded	1 Pc./Card
22977	U.S. Marine Corps Medallion	Carded	1 Pc./Card



22974



22975



22976



22977



NEW ITEMS

JUNE 2017



High Power Single Row LED Light Bar

DESCRIPTION

- 5W High Power Single Row "Cree" LED Light Bar
- Spot/Flood: Inner LEDs (Spot) / Outer LEDs (Flood)
- 12 V Application, IP 67 Rated
- Available in 6 Different Lengths, Heavy Duty Aluminum Housing
- **3 Year Warranty**

Item #	LEDs	Function	Lumens	Length	Pack
36611	6	Spot	2100 lm	7"	1 Pc./Box
36612	8	Spot/Flood	2800 lm	8 3/4"	1 Pc./Box
36613	12	Spot/Flood	4200 lm	12 1/2"	1 Pc./Box
36614	20	Spot/Flood	7000 lm	20 1/2"	1 Pc./Box
36615	30	Spot/Flood	10500 lm	30 1/4"	1 Pc./Box
36616	40	Spot/Flood	14000lm	42"	1 Pc./Box



IP-67
WATERPROOF



Peterbilt 379 Grille Surround

DESCRIPTION

- Grille Surround for Peterbilt 379, Fits Peterbilt 379 Extended Hood
- 4 Piece Grille Surround (Mounting Hardware Not Included)
- Available in Chrome and Black Finish

Item #	Finish	Description	Pack
20910 (New)	Black	Peterbilt Grille Surround	1 Pc./Box
21207	Chrome	Peterbilt Grille Surround	1 Pc./Box



20910



21207

Kenworth T600/T660/T800 Series Mirror Assembly

DESCRIPTION

- Complete Mirror and Mounting Arm Included
- Electric Operation with Heat, Black or Chrome Mirror Cover

Item #	Application	Finish	OEM Number	Pack
42771	Driver	Chrome	10618	1 Pc./Box
42772	Passenger	Chrome	10619	1 Pc./Box
42784 (New)	Driver	Black	10618	1 Pc./Box
42785 (New)	Passenger	Black	10619	1 Pc./Box



42772



42784

Kenworth W900L Grille Surround

DESCRIPTION

- Grille Surround for Kenworth W900
- 4 Piece Grille Surround with 3 Grille Bars
- Mounting Hardware Not Included
- Available in Chrome and Black Finish

Item #	Finish	Description	Pack
20909 (New)	Black	Kenworth Grille Surround	1 Pc./Box
21208	Chrome	Kenworth Grille Surround	1 Pc./Box



20909



21208

Chrome 2008+ International ProStar Grille with Bug Screen

DESCRIPTION

- Chrome Grille with Bug Screen for International ProStar Trucks

Item #	Finish	OEM	Pack
21109	Chrome	3612816C93	1 Pc./Box



Peterbilt Window Visor - Smoke

DESCRIPTION

- Smoke Acrylic Window Visor
- Fits Peterbilt 335/365/367/357/375/377/378/379 & 2003+ 379X
- Double Sided Tape Mount

Item #	Description	Package	Pack
91500	Peterbilt Window Visor	Boxed	1 Pair/Box



Freightliner Cascadia Window Visor - Smoke

DESCRIPTION

- Smoke Acrylic Window Visor
- Fits 2007+ Cascadia And 2014+ Cascadia Evolution
- Double Sided Tape Mount

Item #	Description	Package	Pack
91501	Cascadia Window Visor	Boxed	1 Pair/Box



Chrome Peterbilt DEF Cap Cover

DESCRIPTION

- Chrome Plastic DEF Cap Cover for Peterbilt
- Fits Various Peterbilt Models and Years, Double Sided Tape Mount

Item #	Description	Package	Pack
21265	Peterbilt DEF Cap Cover	Carded	1 Pc./Card



Chrome Freightliner DEF Cap Cover

DESCRIPTION

- Chrome Plastic DEF Cap Cover for Freightliner
- Fits Various Freightliner Models and Years, Double Sided Tape Mount

Item #	Description	Package	Pack
21264	Freightliner DEF Cap Cover	Carded	1 Pc./Card



Stainless 2003+ Volvo VNL Fender Guard

DESCRIPTION

- 304 Stainless Steel Mirror Finish Fender Guard for 2003+ Volvo VNL
- Double Sided Tape Mount, 1 Pair/Card

Item #	Description	Package	Pack
29068	Fender Guard	Carded	1 Pair/Card

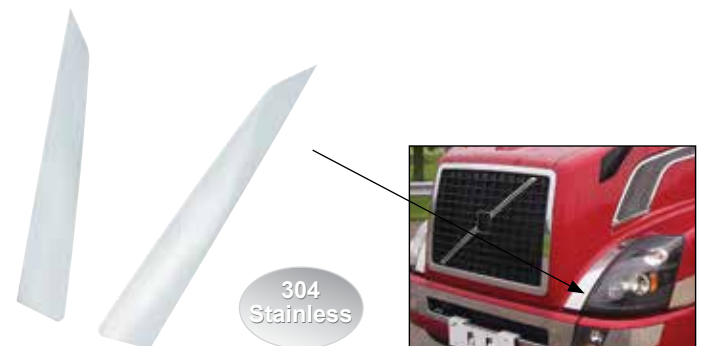

Chrome 2010+ Peterbilt 3-Gauge Cluster Cover



DESCRIPTION

- Chrome Plastic Center Dash 3-Gauge Cluster Cover with Visor
- Fits Peterbilt 579 And Various 2010+ Peterbilt Models and Years

Item #	Application	Description	Pack
41754	Left	3-Gauge Cluster Cover	1 Pc./Card
41755	Right	3-Gauge Cluster Cover	1 Pc./Card



Chrome Peterbilt Dash Data Display Module Control Knob



DESCRIPTION

- Chrome Plastic Peterbilt Dash Data Display Module Control Knob
- Direct Replacement of OEM Control Knob

Item #	Description	Package	Pack
41738	Control Knob	Carded	1 Pc./Card
41759 (New)	Control Knob Bezel	Carded	1 Pc./Card
41772 (New)	Control Knob Set	Carded	1 Set/Card



Chrome Freightliner Cascadia Switch Cover



DESCRIPTION

- Chrome Plastic Freightliner Cascadia Switch Cover, Double Side Tape Installation

Item #	Description	Package	Pack
42417 (New)	Switch Cover w/ 3 Openings	Carded	1 Pc./Card
42350	Switch Cover w/ 2 Openings	Carded	1 Pc./Card



Skulls Pistol Grip 13/15/18 Speed Shift Knob



DESCRIPTION

- Skull Pistol Grip Shift Knob for 13/15/18 Speed Gearshift Knob
- Zinc Die-Cast, Available in Black/Chrome, Chrome, or Matte Black Finish
- Mounting Adapter Available Separately: Item # 70603B
- *Patent Pending*

Item #	Style	Finish	Package	Pack
70744 (New)	Skulls Pistol	Black/Chrome	Carded	1 Pc./Card
70655	Skulls Pistol	Chrome	Carded	1 Pc./Card
70668	Skulls Pistol	Black	Carded	1 Pc./Card



Designer 13/15/18 Speed Shift Knob



DESCRIPTION

- Designer Shift Knob for 13/15/18 Speed Gearshift Knob
- Zinc Die-Cast, Available in Black/Chrome, Chrome, or Matte Black Finish
- Mounting Adapter Available Separately: Item # 70603B
- *Patent Pending*

Item #	Style	Finish	Package	Pack
70636	Challenger	Chrome	Carded	1 Pc./Card
70667	Challenger	Black	Carded	1 Pc./Card
70683	Gatling	Chrome	Carded	1 Pc./Card
70684	Slot	Chrome	Carded	1 Pc./Card
70693	Gatling	Black	Carded	1 Pc./Card
70694	Slot	Black	Carded	1 Pc./Card



New Retail Packaging!

Scorpion License Plate Frame

DESCRIPTION

- High Quality Zinc Die-Cast Metal Frame with Satin Black Finish
- Available with Chrome Scorpions or Black Scorpions

Item #	Description	Finish	Pack
50115 (New)	Scorpion License Frame	Black	1 Pc./Card
50034	Scorpion License Frame	Chrome	1 Pc./Card



50115 (New)



50034

Skulls License Plate Frame

DESCRIPTION

- High Quality Zinc Die-Cast Metal Frame with Satin Black Finish
- Available with Chrome Skulls or Black Skulls

Item #	Description	Finish	Pack
50116 (New)	Skulls License Frame	Black	1 Pc./Card
50037	Skulls License Frame	Chrome	1 Pc./Card



50116 (New)



50037

Flame License Plate Frame

DESCRIPTION

- High Quality Zinc Die-Cast Metal Frame with Satin Black Finish
- Available with Chrome Flames or Black Flames

Item #	Description	Finish	Pack
50117 (New)	Flame License Frame	Black	1 Pc./Card
50038	Flame License Frame	Chrome	1 Pc./Card



50117 (New)



50038

Skulls Pistol Grip Shift Knob

DESCRIPTION

- Skull Pistol Grip Shift Knob
- Zinc Die-Cast, Available in Black/Chrome, Chrome or Matte Black Finish
- Universal Hex Screw Mount Design (Mounting Hardware Included)

Item #	Style	Finish	Package	Pack
70711 (New)	Skulls Pistol	Black/Chrome	Carded	1 Pc./Card
70646	Skulls Pistol	Chrome	Carded	1 Pc./Card
70657	Skulls Pistol	Black	Carded	1 Pc./Card



70711 (New)



70646



70657



United Pacific Work Light Display

DESCRIPTION

- United Pacific Work Light Display

Item #	Description	Package	Pack
99074	Work Light Display	Boxed	1 Pc./Box



Available Now!

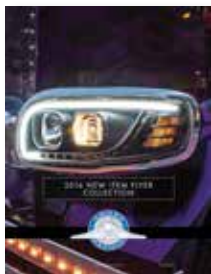

2016 New Item Flyer Collection,
Item # UF1216



OEM Lighting Catalog
- 2nd Edition, Item # UCOEM2

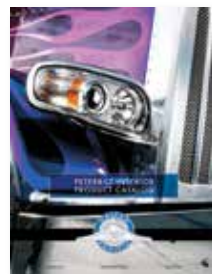

Peterbilt Interior Product Catalog
- 3rd Edition, Item # UCPB3



Fender/Rear Light Bar/Mud Flap
Hanger/Mud Flap Accessories Catalog
- 3rd Edition, Item # UCFM3



NEW ITEMS

JULY 2017



9 LED 2" Clearance / Marker Light - "Mirage"

- 2 Contact Female Plug, Available in Color or Clear Lens
- DOT/SAE Approved, **Lifetime Warranty**
- Recommended Plug: Item # 34210



Mirage

36524 Amber LED/Amber Lens **36526** Amber LED/Clear Lens

36525 Red LED/Red Lens **36527** Red LED/Clear Lens



Stainless Rear Center Panel - "Mirage"

- Polished 430 Stainless Steel Center Panel w/ Enclosed Back Plate
- 23 LED 4" Mirage S/T/T Light with Red or Clear Lens
- 9 LED 2" Mirage Marker Light with Red or Clear Lens
- Includes LED License Light, Chrome License Frame, Bullet Fastener, and Rubber Grommet



Mirage

34498 Red LED/Red Lens/Visor **34499** Red LED/Clear Lens/Visor

Complete Combo Kit in 1 Color Retail Box

- Front Axle Cover Kit (2 Each),
- Rear Axle Cover Kit (4 Each),
- And Nut Cover Tool (1 Pc.),
- All In 1 Color Retail Box



Axle Cover Combo Kit - 33mm

- Chrome Plastic Pointed Axle Cover Combo Kit
- Includes Everything You Need to Dress Up Your Wheels
- Kit Includes:
 - Chrome Plastic Pointed Front Axle Cover x 2
 - Chrome Plastic Pointed Rear Axle Cover x 4
 - Chrome Plastic 33mm Thread-On Nut Cover x 60
 - Nut Cover Tool x 1

10306 Pointed Axle Cover Combo Kit - 33mm



10241 (New)

10278

Chrome Pointed Axle Cover - 33mm Spike

- Chrome Plastic Pointed Axle Cover with 33mm Thread-On Spike Nut Cover
- Removable Pointed Hub Cap

10241 Front Spike Axle Cover **10278** Rear Spike Axle Cover



Stainless Spring Loaded Rear Light Bar - 2 1/2" Bolt Pattern

- Spring Loaded Rear Light Bar with Six 4" LED "Mirage" Lights
- 2 1/2" Bolt Pattern, 430 Stainless Steel Light Bar
- 23 LED 4" Mirage S/T/T Light with Red or Clear Lens

22252 Red LED/Red Lens/Visor **22253** Red LED/Clear Lens/Visor



21469 (New)

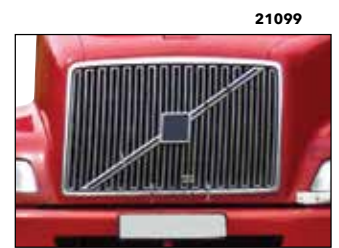

21099

1996 - 2003 Volvo VN/VNL Grille

- Fits 1996-2003 Volvo VN/VNL Trucks, **OEM #: 8084221**
- Available in Chrome or Black Finish

21099 Chrome VN/VNL Grille **21469** Black VN/VNL Grille



22960



22961



22962



22963



22978B

Deluxe Air Valve Knobs - Military Medallion

- Deluxe Air Valve Knob with U.S. Military Metal Medallion

22960 Air Force

22962 Navy

22961 Army

22963 Marine

22978B Dash Knob Only



21911



21912



21913

12" Shifter Shaft Extender

- Thread On (1/2" - 13 UNC Thread), Thread 1" Long
- 3/4" Diameter Thickness
- For Off-Road and Show Use Only

21911 Indigo Blue

21912 Emerald Green

21913 Candy Red



99099 United Pacific Flat Bill Cap

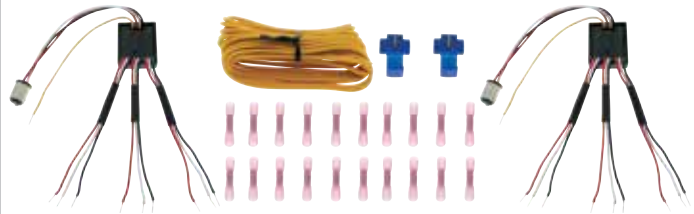

UPGRADED

Features Sequence Once Brake Attention Function

Sequential LED Module Kit

- Features Sequence Once Brake Attention Function
- This Kit Will Convert Three 12 Volt LED Tail Lights to Sequential Operation
- Kit Includes Two Sequencer Modules, Hookup Wire, Wire Connectors and Instructions

90656 Sequential LED Module Kit

Now Available in Color Retail Package



1990-2007 Freightliner FLD Turn Signal

- Incandescent Freightliner FLD Front Turn Signal Lamp, Bulb & Socket Included
- Fits 1990-2007 Freightliner FLD Trucks with Integral Sleeper
- Fits Freightliner FLDs with 2 Piece Clip-On Turn Signal Headlight Bezel
- Sold Individually, Please Specify Driver or Passenger Side
- OEM #: A06-17139-001/ A06-17139-000

32353 Driver

32354 Passenger



2000+ Freightliner Columbia Fog Light

- Replacement Fog Light for 2000+ Freightliner Columbia Trucks
- OEM # A06-32497000

31327 Columbia Fog Light



NEW ITEMS

AUGUST 2017

7" High Power LED Projection Headlight with Dual Function LED Halo Ring

- 7" Headlight: 2,700 Lumen High Beam and 1,200 Lumen Low Beam
- Dual Color White/Amber Auxiliary LED Halo Ring with Amber Automatic Override Feature
- Die Cast Housing and Polycarbonate Lens Provide Maximum Protection and Durability
- Solid State Design Resists Shock and Vibration, IP67 Weatherproof Rating
- Easy Installation. Fits OEM Housing and Plugs Into Existing Headlight Wiring Harness
- LED Halo Ring Requires Additional Wiring Installation
- DOT and SAE Headlight Compliant
- Sold Each

31496 1 Pc. / Color Packaging



DUAL FUNCTION HALO

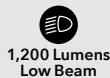
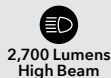

DOT & SAE APPROVED

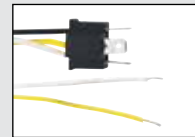

NEW COLOR PACKAGING
CONTACT US FOR DETAILS



5" x 7" LED Rectangular Light with LED Light Bar

- 9 High Power LED 5" x 7" Rectangular Light
- High and Low Function
- Reinforced Aluminum Reflector
- Rugged Anti-Vibration Construction

34122 1 Pc. / Box



6 High Power LED Rectangular Driving/Work Light

- Heavy Duty Die Cast Aluminum Housing, 1,150 Lumens
- Stainless Steel Mounting Bracket and Hardware
- Operates on 9V-30V, Draws 1.4 Amps at 12V
- **3 Year Warranty**

36510 1 Pc. / Card

1,150 LUMENS

3w X 6
HIGH POWER

9v-30v
MULTIPLE VOLTAGE





24 LED 4" S/T/T Reflector Light

- 24 LED 4" Round S/T/T Reflector Light
- 3 Contact Female Plug, DOT/SAE Compliant
- Recommended Plug: Item # 34212/34216
- **Lifetime Warranty**

36511 1 Pc. / Card



30 LED 4" S/T/T Light - Competition Series

- 30 LED 4" Round S/T/T Light
- 3 Contact Female Plug, DOT/SAE Compliant
- Recommended Plug: Item # 34212/34216
- **Lifetime Warranty**

36832B NEW 1 Pc. / Bulk **36832** 1 Pc. / Card



7 LED 4" S/T/T Light Kit

- 7 LED 4" Round S/T/T Light Kit
- Kit Includes Light, Grommet (Item # 31515) and Plug (Item # 34212)
- **Lifetime Warranty**

39652BRK 1 Pc. / Bulk



Volvo VN & VNL 1998 - 2004 / VHD 2001 - 2003 Window Crank

- Gray Volvo Window Crank
- Fits 1998 - 2004 Volvo VN & VNL & 2001 - 2003 Volvo VHD Trucks
- OEM #: 8140016

41688 1 Pc. / Card



41678



41677

Volvo VNL 2004+ Chrome Hood Mirror Cover

- Chrome Plastic Hood Mirror Cover for 2004+ Volvo VNL Trucks
- OEM #134721031 (Driver) / #134721032 (Passenger)
- Sold Individually, Please Specify Driver or Passenger Side

41677 Driver - 1 Pc. / Card **41678 Passenger** - 1 Pc. / Card





10254 **NEW**



10261



NEW COLOR PACKAGING
CONTACT US FOR DETAILS

Chrome Pointed Axle Cover - 33mm Nut Cover

- Chrome Plastic Pointed Axle Cover with 33mm Thread-On Nut Cover
- Removable Pointed Hub Cap

10254 Front Axle - 1 Pc. / Color Packaging **10261 Rear Axle** - 1 Pc. / Color Packaging



70407



70408



70409



Detailed Texture

18" Carbon Fiber Style Steering Wheel Cover

- 18" Engineered Leather, Carbon Fiber Style Steering Wheel Cover
- Unique Euro Style, Two Color Design

70407 Black - 1 Pc. / Card **70408 Blue** - 1 Pc. / Card **70409 Red** - 1 Pc. / Card



50114 **NEW**



50033

Tribal Flame License Plate Frame

- High Quality Zinc Die-Cast Metal Frame
- Available Chrome/Black Finish or All Satin Black Finish
- Fits Standard U.S. & Canadian 6" x 12" License Plates
- Sold Each

50114 Black - 1 Pc. / Card

50033 Black/Chrome - 1 Pc. / Card



United Pacific LED Gearshift Knob Display

- United Pacific LED Gearshift Knob Display
- Includes 4 LED Gearshift Knobs

99101 1 Pc. / Box



NEW ITEMS

SEPTEMBER 2017

Axle Cover Combo Kit - 33mm Spike

- Chrome Plastic Axle Cover Combo Kit with 33mm Spike Nut Covers
- Includes Everything You Need to Dress Up Your Wheels
- Kit Includes:
 - Chrome Plastic Pointed Front Axle Cover x 2
 - Chrome Plastic Pointed Rear Axle Cover x 4
 - Chrome Plastic Spike 33mm Thread-On Nut Cover x 60
 - Nut Cover Tool x 1

10308 1 Kit / Color Box

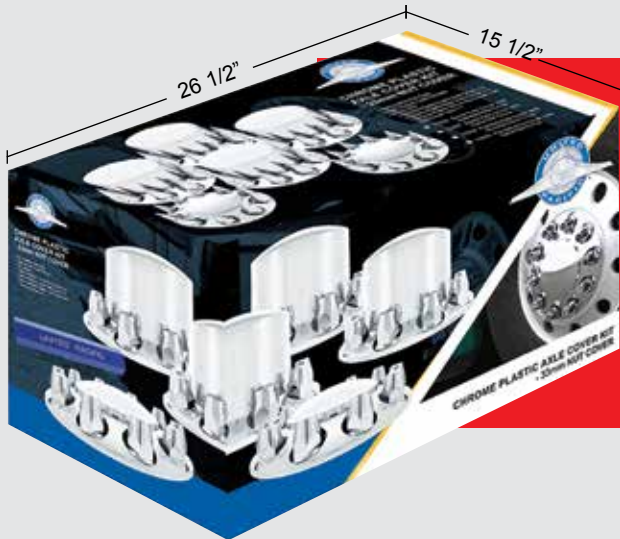

**Complete Combo Kit
in Retail Color Box.**

**Kit Includes 2 Front Axle Cover Kits,
4 Rear Axle Cover Kits,
And Nut Cover Installation Tool**

REAR AXLE COVER KIT x 4

Item # 10278



FRONT AXLE COVER KIT x 2

Item # 10241



NUT COVER TOOL

Item # 10259



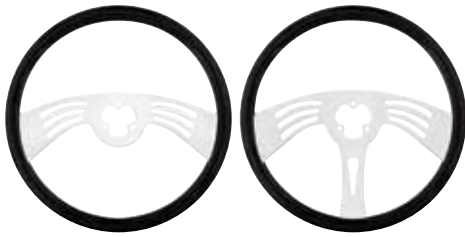

88258 **NEW**

88257 **NEW**



88237



NEW COLOR PACKAGING

18" Carbon Black Woodgrain Steering Wheel

- 18" Diameter with a Deep Luxurious Carbon Black Woodgrain Finish
- Steering Wheel Only, Hub and Horn Assembly Available Separately
- Mix and Match with United Pacific Hub and Designer Horn Bezel for a Unique and Distinctive Look

88258 **2 Spoke** - 1 Pc. / Color Box

88257 **3 Spoke** - 1 Pc. / Color Box

88237 **4 Spoke** - 1 Pc. / Color Box



21910
NEW

21911

21912

21913

21915
NEW

21916
NEW

21793

21796

12" Shifter Shaft Extender

- Thread On (1/2" - 13 UNC Thread), Thread 1" Long
- 3/4" Diameter Thickness

21910 **Cadmium Orange** - 1 Pc. / Card

21911 **Indigo Blue** - 1 Pc. / Card

21912 **Emerald Green** - 1 Pc. / Card

21913 **Candy Red** - 1 Pc. / Card

21915 **Pearl White** - 1 Pc. / Card

21916 **Electric Yellow** - 1 Pc. / Card

21793 **Chrome** - 1 Pc. / Card

21796 **Black** - 1 Pc. / Card



31169 **NEW**



31238

DUAL FUNCTION AMBER POSITION LIGHT



NEW COLOR PACKAGING

6" x 4" Rectangular High Power LED High Beam Headlight with 6 LED Position LED

- 1 High Power LED for Headlight and 6 LED for Position Light
- Improves Visibility with Whiter High Beam Output that is Closer to Daylight
- Die-Cast Aluminum Housing Provides Maximum Protection from the Elements
- Solid State Design Resists Shock and Vibration
- Available in Single Function White Position LED or Dual Function High/Low Amber Position LED
- SAE/DOT FMVSS108

Technical Specification

LED High Beam		
12 - 24V DC Input	0.6 Amps / 14.5 Watt	FMVSS 108

31169 **White LED Position Light** - 1 Pc. / Color Packaging

31238 **Amber LED Position Light** - 1 Pc. / Color Packaging

Chrome Eagle Accent

- Highly Detailed Bald Eagle Design
- Show Quality Chrome Plating on Durable Weather Resistant Plastic
- Approximately 7 3/16" L x 1 3/4" W x 1/2" H
- Double Sided Tape Mount



50119 1 Pc. / Card





2015+ Volvo VN / VNL Center Bumper

- Black Plastic Center Bumper for 2015+ Volvo VN and VNL
- Black Finish
- OEM Number: 82741337

20911 1 Pc. / Box



International ProStar Hood Mirror

- Hood Mirror Assembly for International ProStar Trucks
- Stainless Steel Arm with Chrome Plastic Mirror Cover
- OEM Number: 3594843C3 - Driver / 3594844C3 - Passenger
- Sold Individually, Please Specify Driver or Passenger Side

42224 Driver - 1 Pc. / Box

42225 Passenger - 1 Pc. / Box



42226



International ProStar Chrome Hood Mirror - Mirror Only

- Chrome Plastic Hood Mirror Only for International ProStar Trucks
- Replacement Hood Mirror for International ProStar Trucks

42226 Mirror Only - 1 Pc. / Box



36484



36488



36485



36489



36486



36490

12" LED Light Bar with Black Housing

- 12" LED Light Bar with Black Housing, For Flush Mount on Any Flat Surface
- Universal Application, Stainless Steel Mounting Screws Can be Moved to Accommodate Mounting Distance from 4 1/2" - 7 3/8" Apart
- 12" Black Plastic Light Bar Housing Available Separately: Item # 30973B

Regular

36484	14 Amber LED/Amber Lens - 1 Pc. / Card
36485	14 Red LED/Red Lens - 1 Pc. / Card
36486	14 Amber LED/Clear Lens - 1 Pc. / Card
36487	14 Red LED/Clear Lens - 1 Pc. / Card

Reflector

36488	19 Amber LED/Amber Lens - 1 Pc. / Card
36489	19 Red LED/Red Lens - 1 Pc. / Card
36490	19 Amber LED/Clear Lens - 1 Pc. / Card
36491	19 Red LED/Clear Lens - 1 Pc. / Card



36492



36493



36494



36495

12" LED Light Bar with Black Housing - GLO Light

- 12" LED Light Bar with Black Housing, For Flush Mount on Any Flat Surface
- Universal Application, Stainless Steel Mounting Screws Can be Moved to Accommodate Mounting Distance from 4 1/2" - 7 3/8" Apart
- 12" Black Plastic Light Bar Housing Available Separately: Item # 30973B

GloLight

36492	24 Amber LED/Amber Lens - 1 Pc. / Card
36493	24 Red LED/Red Lens - 1 Pc. / Card

36494	24 Amber LED/Clear Lens - 1 Pc. / Card
36495	24 Red LED/Clear Lens - 1 Pc. / Card

Black 12" LED Light Bar Housing

- Black Housing for United Pacific 12" LED Light Bar
- For Flush Mount on Any Flat Surface
- Universal Application, Stainless Steel Mounting Screws Can be Moved to Accommodate Mounting Distance from 4 1/2" - 7 3/8" Apart

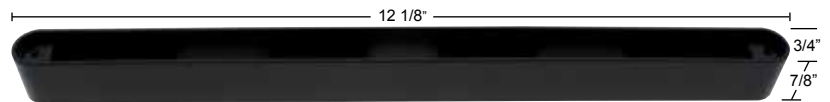

30973B	1 Pc. / Bulk
--------	--------------



36472



36477



36474



36478

Black License Plate Frame with 12" LED Light Bar

- Black License Plate Frame with 12" LED Light Bar
- Black License Plate Frame with LED Light Bar Cut Out Available Separately: Item # 50064B
- 12" Black Plastic Light Bar Housing Available Separately: Item # 30973B

Regular

- 36472** 14 Amber LED/Amber Lens - 1 Pc. / Card
- 36473** 14 Red LED/Red Lens - 1 Pc. / Card
- 36474** 14 Amber LED/Clear Lens - 1 Pc. / Card
- 36475** 14 Red LED/Clear Lens - 1 Pc. / Card

Reflector

- 36476** 19 Amber LED/Amber Lens - 1 Pc. / Card
- 36477** 19 Red LED/Red Lens - 1 Pc. / Card
- 36478** 19 Amber LED/Clear Lens - 1 Pc. / Card
- 36479** 19 Red LED/Clear Lens - 1 Pc. / Card



36480



36481



36482

Black License Plate Frame with 12" LED Light Bar - GLO Light

- Black License Plate Frame with 12" LED Light Bar
- Black License Plate Frame with LED Light Bar Cut Out Available Separately: Item # 50064B
- 12" Black Plastic Light Bar Housing Available Separately: Item # 30973B

GloLight™

- 36480** 24 Amber LED/Amber Lens - 1 Pc. / Card
- 36481** 24 Red LED/Red Lens - 1 Pc. / Card

- 36482** 24 Amber LED/Clear Lens - 1 Pc. / Card
- 36483** 24 Red LED/Clear Lens - 1 Pc. / Card

Black License Plate Frame with LED Light Bar Cut Out

- Black License Plate Frame with LED Light Bar Cut Out
- Design for United Pacific 12" or 9" Light Bar Only
- License Frame Only
- 12" Black Plastic Light Bar Housing Available Separately: Item # 30973B

50064B 1 Pc. / Bulk

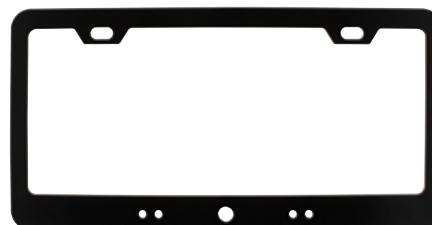

Chrome Motorcycle Dual Tone Horns

- Super Loud 115 Decibel Sound
- Dual Tones: Low 410 HZ and High 510HZ
- Compact Design Ideal for Motorcycles & PowerSport Vehicles
- 12 Volt, Mounting Hardware Included

46101 1 Set / Card



50118



50124

Eagle Motorcycle License Plate Frame

- High Quality Zinc Die-Cast Metal Frame
- Available in Chrome and Chrome/Black Finish
- Fits All U.S. Motorcycle License Plates

50118 **Chrome** - 1 Pc. / Card

50124 **Chrome/Black** - 1 Pc. / Card



50128



50129

Flame Motorcycle License Plate Frame

- High Quality Zinc Die-Cast Metal Frame
- Available in Chrome and Chrome/Black Finish
- Fits All U.S. Motorcycle License Plates

50128 **Chrome** - 1 Pc. / Card

50129 **Chrome/Black** - 1 Pc. / Card



NEW ITEMS

OCTOBER 2017

100% LED

DOT & SAE APPROVED



NEW COLOR PACKAGING



Peterbilt 388/389 LED Headlight with LED Turn Signal & LED Position Light Bar

- All LED Peterbilt 388/389 Headlight
- LED High and Low Beam Module, LED Turn Signal, and LED Position Light Bar
- Available in Chrome or Blackout Design
- Sold Individually, Please Specify Driver or Passenger Side
- **1 Year Warranty**

Technical Specification

Low Beam Application	High Beam Application
1000 Lumens	2000 Lumens
2.3 Amps / 28 Watt	4.6 Amps / 56 Watt
FMVSS 571.108	FMVSS 571.108

35800	Chrome	Driver - 1 Pc. / Color Box
35801	Chrome	Passenger - 1 Pc. / Color Box
35806	Blackout	Driver - 1 Pc. / Color Box
35807	Blackout	Passenger - 1 Pc. / Color Box



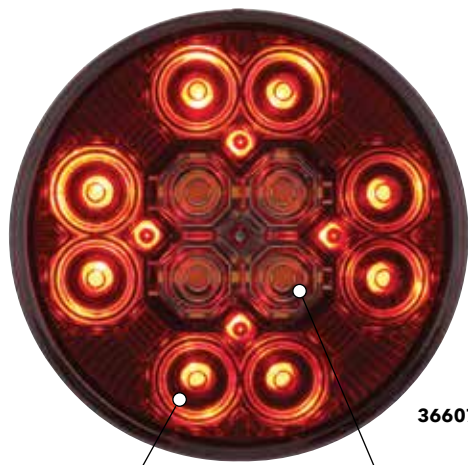

Stop/Turn/Tail

Back-Up/Reverse

36607



36608



3 Contact Female Plug for Stop/Turn/Tail

3 Contact Female Plug for Back-Up



4" Round Combo Light with 12 LED S/T/T Light & 16 LED Back-Up Light

- 4" Round Stop/Turn/Tail Light with Back-Up Function
- 3 Contact Female Plug, Available in Color or Clear Lens
- DOT/SAE Approved
- Recommended Plug: Item # 34211/34212/34216
- [Lifetime Warranty](#)

36607

Red Lens - 1 Pc. / Card

36608

Clear Lens - 1 Pc. / Card

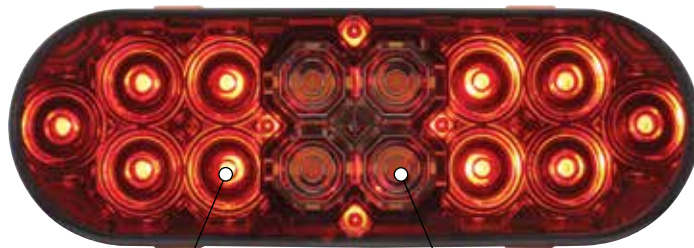

Stop/Turn/Tail

36609

Back-Up/Reverse



36610



3 Contact Female Plug for Stop/Turn/Tail

3 Contact Female Plug for Back-Up

6" Oval Combo Light with 14 LED S/T/T Light & 16 LED Back-Up Light

- 6" Oval Stop/Turn/Tail Light with Back-Up Function
- 3 Contact Female Plug, Available in Color or Clear Lens
- DOT/SAE Approved
- Recommended Plug: Item # 34211/34212/34216
- [Lifetime Warranty](#)

36609

Red Lens - 1 Pc. / Card

36610

Clear Lens - 1 Pc. / Card



9 High Power LED Driving/Work Light with Side LED - Spot/Flood Light

- 6 LEDs at Front - Spot Light and 3 LEDs at Side - Flood Light
- Stainless Steel Mounting Bracket and Hardware
- Operates on 12V-24V, Draws 2.8 Amps at 12V
- **3 Years Warranty**

2,400
LUMENS

5w X 6
HIGH POWER

12v-24v
MULTIPLE VOLTAGE

36509

1 Set / Box

New Retail Packaging!



39817



39818



39819



39820B



NEW COLOR PACKAGING

16 LED Reflector Rectangular Clearance/Marker Light

- 16 LED Rectangular Marker Light with Reflector and Chrome Bezel
- Available with 16 Amber or Red LEDs with Colored or Clear Lens
- Unique Reflector Design Projects Light in Multiple Directions
- Mounting Holes are 4 7/8" Apart
- **Lifetime Warranty**

39817 Amber LED/Amber Lens - 1 Pc. / Card

39817B Amber LED/Amber Lens - 1 Pc. / Bulk

39818 Red LED/Red Lens - 1 Pc. / Card

39818B Red LED/Red Lens - 1 Pc. / Bulk

39819 Amber LED/Clear Lens - 1 Pc. / Card

39819B Amber LED/Clear Lens - 1 Pc. / Bulk

39820B Red LED/Clear Lens - 1 Pc. / Bulk



20482



20484

20485



2008+ Freightliner Cascadia Center Bumper Assembly

- Center Bumper Assembly for Freightliner Cascadia
- Available with or without Mounting Holes for the Chrome Center Bumper Trim
- Chrome Center Bumper Trim Available Separately: Item # 20799

20481	Without Hole - 1 Pc. / Box
20482	With Hole - 1 Pc. / Box

2008+ Freightliner Cascadia Bumper End Assembly

- Bumper End Assembly for 2008+ Freightliner Cascadia
- Available with or without Fog Light Hole
- Sold Individually, Please Specify Driver or Passenger Side

20483	Driver - 1 Pc. / Box
20484	Passenger - 1 Pc. / Box
20485	With Fog Light Cut Out / Driver - 1 Pc. / Box
20486	With Fog Light Cut Out / Passenger - 1 Pc. / Box



42814

42815



42818

42819



2015+ Volvo VN / VNL Bumper End - Screw Mount

- Bumper End for 2015+ Volvo VN / VNL
- 4 Screw Mount with Protruding Center
- Available with or without Fog Light Hole
- OEM Number 82741344 / 82741346
- Sold Individually, Please Specify Driver or Passenger Side

42813	Driver - 1 Pc. / Box
42814	Passenger - 1 Pc. / Box
42815	With Fog Light Cut Out / Driver - 1 Pc. / Box
42816	With Fog Light Cut Out / Passenger - 1 Pc. / Box

2015+ Volvo VN / VNL Short Hood Bumper End - Screw Mount

- Bumper End for 2015+ Volvo VN / VNL Short Hood
- 4 Screw Mount with Protruding Center
- Available with or without Fog Light Hole
- OEM Number 82741354 / 82741352
- Sold Individually, Please Specify Driver or Passenger Side

42817	Driver - 1 Pc. / Box
42818	Passenger - 1 Pc. / Box
42819	With Fog Light Cut Out / Driver - 1 Pc. / Box
42820	With Fog Light Cut Out / Passenger - 1 Pc. / Box



10"



33 mm Thread-On Extra Tall Rear Axle Cover Set

- Chrome Plastic Rear Axle Cover with Removable Cap
- Universal Fit, Fits Most 11 1/4" and Bolt Circle/Center Applications
- Available with 33 mm Thread-On Nut Cover
- Fits 10-Hole, 22 1/5" and 24 1/5" Hub and Stud Piloted Wheels
- Includes 1 Cover, 1 Cap, and 10 Nut Covers Per Kit

10239 1 Kit/ Color Box

10"



10239



10263

8 3/5"



NEW COLOR PACKAGING



12"



33 mm Thread-On Spike Rear Axle Cover Set

- Chrome Plastic Spike Rear Axle Cover with Removable Cap
- Universal Fit, Fits Most 11 1/4" and Bolt Circle/Center Applications
- Available with 33 mm Thread-On Nut Cover
- Fits 10-Hole, 22 1/5" and 24 1/5" Hub and Stud Piloted Wheels
- Includes 1 Cover, 1 Cap, and 10 Nut Covers Per Kit

10249 1 Kit/ Color Box

12"



10249



10261

9"



NEW COLOR PACKAGING

Automotive Candy Finish



70591



70592



70593



70594



70595



70596



70597



70176



13/15/18 Speed Gearshift Knob

- 13/15/18 Speed Gearshift Knob for Eaton Fuller Shift Knob Assemblies
- Premium Automotive Paint in Vibrant Candy Colors, Bold Effects and Dazzling Color
- Gearshift Cover Available Separately, Item # 70176-2

70591 Cadmium Orange - 1 Pc. / Card

70592 Indigo Blue - 1 Pc. / Card

70593 Emerald Green - 1 Pc. / Card

70594 Candy Red - 1 Pc. / Card

70595 Liquid Silver - 1 Pc. / Card

70596 Pearl White - 1 Pc. / Card

70597 Electric Yellow - 1 Pc. / Card

70176 Chrome - 1 Pc. / Card

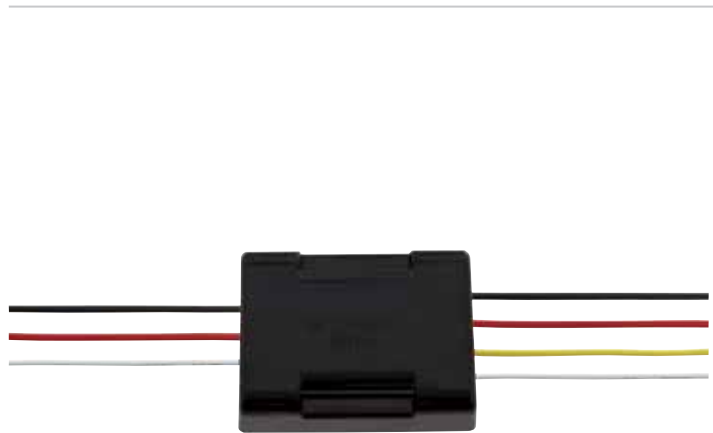

LED Warning Module

- LED for Warning Module for Use with One LED
- Converts Regular LED lights Into Flashing Warning Lights
- 15 Selectable Flash Patterns
- 12 Volt, 5 AMP Maximum LED Load

90661 1 Pc. / Card

Recommended Item

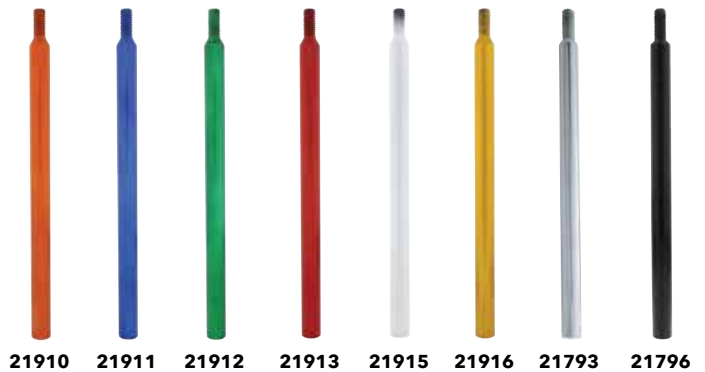

12" Shifter Shaft Extender

- Thread On (1/2" - 13 UNC Thread), Thread 1" Long
- 3/4" Diameter Thickness

21910 Cadmium Orange - 1 Pc. / Card

21911 Indigo Blue - 1 Pc. / Card

21912 Emerald Green - 1 Pc. / Card

21913 Candy Red - 1 Pc. / Card

21915 Pearl White - 1 Pc. / Card

21916 Electric Yellow - 1 Pc. / Card

21793 Chrome - 1 Pc. / Card

21910 Black - 1 Pc. / Card



32170B



32171-14

5 3/4" Headlight Retaining Ring

- Universal Design, Fits All 5 3/4" Headlight

32170B 1 Pc. / Bulk



Kenworth T660 Chrome Center Dash Instrument Bezel

- Chrome Plastic Center Dash Instrument Bezel for Kenworth T660

41445 1 Pc. / Card



42199B

2008+ Mack Pinnacle & 2000 - 2008 Mack Vision Black Exterior Door Handle

- Black Exterior Door Handle for 2008+ Mack Pinnacle and 2000-2008 Mack Vision
- OEM Number : 25191926/25191943, 25191953/25191915
- Sold Individually, Please Specify Driver or Passenger Side

42198B **Driver** - 1 Pc. / Box

42199B **Passenger** - 1 Pc. / Box



NEW COLOR PACKAGING

Now In Color Package

24" x 24" Black Poly Quarter Fender

- Heavy Duty Black 24" x 24" Polymer Quarter Fender, the Black Polymer Material is Chip, Dent and Scuff Resistant
- Internal Mounting System, Eliminates the Need for U-Bolts and Other External Hardware
- Includes Tube Bracket, Clamp and Bolts
- As Pictured, Frame Mounting Post Sold Separately (Item # 10831), Includes Hard Plastic Top Flap and Bolts

10711 1 Pair / Color Box



NEW ITEMS

NOVEMBER 2017



Single Function White DRL

31513

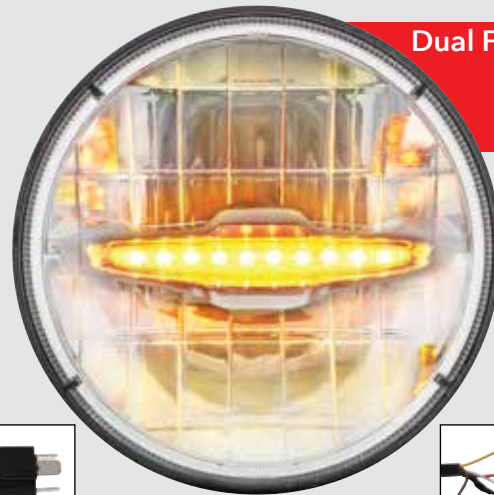

Dual Function Amber Signal Light

31514

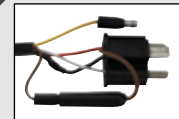

NEW COLOR PACKAGING

7" High Power LED Headlight with 10 LED Dual-Function Position Light Bar

- 3 High Power 7W LEDs for Exceptional Performance
- 900 Lumens Output on Low and 1,600 Lumens Output on High
- White Position Light Bar Can Be Wired as Daytime Running Light, Amber Position Light Bar Can Be Wired as Turn Signal
- Easy Installation, Fits OEM Housing, Plugs into Existing Wiring Harness
- DOT/SAE and FMVSS108 Headlight Compliant

Technical Specification

Low Beam Application

900 Lumens
9V-33V DC Input
FMVSS108

High Beam Application

1,600 Lumens
9V-33V DC Input FMVSS108

31513	w/Daytime Running Light	1 Pc. / Color Box
31514	w/Amber Auxiliary Light	1 Pc. / Color Box



NEW COLOR PACKAGING

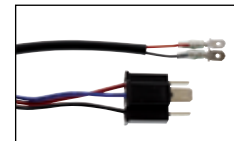

5" x 7" LED Rectangular Light with LED Light Bar

- 7 High Power LED Headlight with 3 LED Position Light Bar
- High and Low Function
- Reinforced Aluminum Reflector
- Easy Installation, Fits OEM Housing, Plugs into Existing Wiring Harness
- IP 66 Rated, DOT/SAE Headlight Approved

Technical Specification

Low Beam Application

1,680 Lumens
12V-24V DC Input
1.15 AMPS

High Beam Application

2,850 Lumens
12V-24V DC Input
2.7 AMPS

31120	1 Pc. / Color Box
--------------	-------------------



COMPETITION
SERIES

8 High Power LED Rectangular Work Light with Chrome Reflector

- Heavy Duty Die Cast Aluminum Housing, 1,200 Lumens
- Stainless Steel Mounting Bracket and Hardware
- Operates on 10V-32V, Draws 1.66 Amps at 12V
- 3 Years Warranty

1,200
LUMENS

3w X 8
HIGH POWER

IP-67
WATERPROOF

10v-32v
MULTIPLE VOLTAGE



36507 1 Pc. / Color Box

NEW COLOR PACKAGING



COMPETITION
SERIES

8 High Power LED Rectangular Work Light with Projector Lens

- Heavy Duty Die Cast Aluminum Housing, 1,200 Lumens
- Stainless Steel Mounting Bracket and Hardware
- Operates on 10V-32V, Draws 1.66 Amps at 12V
- 3 Years Warranty

1,200
LUMENS

3w X 8
HIGH POWER

IP-67
WATERPROOF

10v-32v
MULTIPLE VOLTAGE



36508 1 Pc. / Color Box

NEW COLOR PACKAGING



24 Red LED 4" "MIRAGE" Stop, Turn & Tail Light

- 24 LED 4" Round S/T/T "Mirage" Light
- 3 Contact Female Plug, Available in Color or Clear Lens
- DOT/SAE Approved
- Recommended Plug: Item# 34212/34216
- **Lifetime Warranty**

36652B	Red LED/Red Lens - 1 Pc. / Bulk	NEW
36652	Red LED/Red Lens - 1 Pc. / Card	
36654B	Red LED/Clear Lens - 1 Pc. / Bulk	NEW
36654	Red LED/Clear Lens - 1 Pc. / Card	



9 Red LED 2" "MIRAGE" Clearance / Marker Light

- 2 Contact Female Plug, Available in Color or Clear Lens
- DOT/SAE Approved
- Recommended Plug: Item# 34210
- **Lifetime Warranty**

36525B	Red LED/Red Lens - 1 Pc. / Bulk	NEW
36525	Red LED/Red Lens - 1 Pc. / Card	
36527B	Red LED/Clear Lens - 1 Pc. / Bulk	NEW
36527	Red LED/Clear Lens - 1 Pc. / Card	



Mack Chrome Small Gauge Cover with Visor

- Chrome Plastic Small Gauge Cover for Various Mack Trucks
- Available with 2 Small Gauge or 3 Small Gauge

41852	2 Gauge - 1 Pc. / Card
41853	3 Gauge - 1 Pc. / Card



1990+ Kenworth T170/T270/T370/T440/T470/T600/T660/T800 Black Mirror Cover

- Black Mirror Cover for Kenworth T170/T270/T370/T440/T470/T600/T660/T800 Trucks
- OEM #: R59-1019-21/ R59-1010-21

42791B	Driver - 1 Pc. / Box
42792B	Passenger - 1 Pc. / Box



Peterbilt Chrome Eagle Emblem

- Chrome Diecast Peterbilt Eagle Emblem
- Same Size As OEM Emblem, 8" x 3 1/4"
- Mounting Studs are 6 1/4" Apart
- Speed Nuts Included

10964 1 Pc. / Card



Peterbilt Chrome Mexico Flag Emblem

- Chrome Diecast Peterbilt Flag Emblem
- Same Size As OEM Emblem, 8" x 3 1/4"
- Mounting Studs are 6 1/4" Apart
- Speed Nuts Included

10924 1 Pc. / Card



Chrome Eagle Accent

- Highly Detailed Bald Eagle Design
- Show Quality Chrome Plating on Durable Weather Resistant Plastic
- Approximately 7 3/16" L x 1 3/4" W x 1/2" H
- Double Sided Tape Mount

50119 1 Pc. / Card



70745

70746



Pistol Grip Shift Knob

- Pistol Grip Shift Knob
- Zinc Die-Cast, Available in Space Gray and Rose Gold
- Universal Hex Screw Mount Design (Mounting Hardware Included)

70745 **Space Gray** - 1 Pc. / Card

70746 **Rose Gold** - 1 Pc. / Card



**NEW COLOR
PACKAGING**

Swan Hood Ornament

- Chrome Large Swan Hood Ornament
- Universal Two Stud Installation

72001 1 Pc. / Card



Freightliner Century Replacement Mirror with 16 Amber LED Turn Signal

- 16 Amber LED Turn Signal Replacement Mirror for Freightliner Century
- Double Side Tape Mount
- For Off-Road and Show Use Only

39445 1 Pair / Color Box



Mack West Coast Replacement Mirror with 16 Amber LED Turn Signal

- 16 Amber LED Turn Signal Replacement Mirror for Mack West Coast
- Double Side Tape Mount
- For Off-Road and Show Use Only

39446 1 Pair / Color Box



Glad Hand Lock - Lock Keyed Alike

- Heavy Duty Molded Plastic Glad Hand Lock with 2 Keys
- Trailer Lockout Device, Immobilizes your Trailer, Prevent and Deters Theft of Trailer
- Increases Safety During Loading and Unloading

90630 1 Pc. / Card



United Pacific Table Top Bin

- United Pacific P.O.P. Display
- Table Top Bin

99051 1 Pc. / Box



NEW ITEMS

DECEMBER 2017

**DOT & SAE
APPROVED**



31158 - Chrome Version



31161 - Blackout Version



Uses Factory Harness - Plug and Play

2008 - Early 2018 Kenworth T660 Projection Headlight with LED Turn Signal

- 2008 - Early 2018 Kenworth T660 Projection Headlight with LED Turn Signal
- DOT/SAE and FMVSS108 Compliant
- Available in Chrome or Blackout Design
- Sold Individually, Please Specify Driver or Passenger Side
- **1 Year Warranty**

Technical Specification

Low Beam Application	High Beam Application
12V DC Input	12V DC Input
4.1 Amps / 49.2 Watt	5 Amps / 60 Watt
FMVSS 108	FMVSS 108

31158	Chrome	Driver - 1 Pc. / Box
31159	Chrome	Passenger - 1 Pc. / Box
31160	Blackout	Driver - 1 Pc. / Box
31161	Blackout	Passenger - 1 Pc. / Box





8 High Power LED 5 3/4" Headlight

- 1,020 Lumens Output on Low and 1,600 Lumens Output on High
- Replaces H5001 and H5006 Bulb
- Easy Installation, Fits OEM Housing, Plugs into Existing Wiring Harness
- DOT/SAE and FMVSS108 Headlight Compliant

31201 Silver - 1 Pc. / Card

31202 Black - 1 Pc. / Card

Technical Specification

Low Beam Application

12.8V DC Input
1020 Lumens
0.9 Amps / 12 Watt
FMVSS 108

High Beam Application

12.8V DC Input
1600 Lumens
1.5 Amps / 20 Watt
FMVSS 108



2014+ Peterbilt Chrome Rocker Switch Cover - 2 Openings

- Chrome Plastic Rocker Switch Cover for 2015+ Peterbilt 567 and 2014+ Peterbilt 579/587
- Also Compatible with Some Kenworth Trucks

41449 3 Pcs. / Card



Deluxe Air Blow Gun Kit

- Deluxe Truck Air Blow Gun Kit
- Complete Air Blow Kit for Use On Trucks With On-Board Air Supply
- Includes Chrome Plated Bow Gun With Two Interchangeable Nozzles
- Includes Brass T-Compression Fitting For Splicing Into Air-Seat Air Supply Line
- Coiled 1/4" NTA Nylon-12 Hose Extends Over 10 Feet
- Meets DOT and SAE J844 Type-A Specification
- Convenient Accessory To Keep Your Truck Interior Clean

89998 1 Pc. / Card

Spring Loaded Rear Light Bar - 3 3/4" Bolt Pattern

- Spring Loaded Rear Light Bar with Six 4" Round LED "GLO" Lights
- Available with 3 3/4" Bolt Pattern, Light Bar Available in Chrome or Stainless
- Available with Chrome Plastic Light Bezel with Visor (Item # 10483) and Rubber Grommet (Item # 31515)



GloLight™

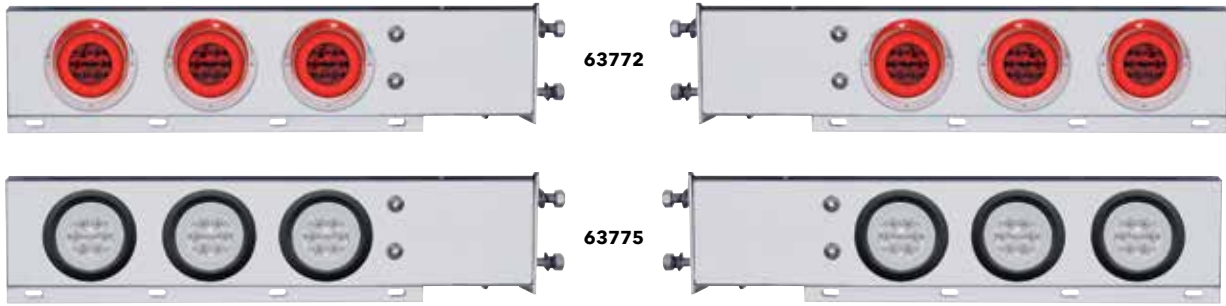

Item # with Visor	Item # with Grommet	LED Lights				Rear Light Bar	
		4" LED "GLO" Light	Item #	LEDs	Lens	Item #	Finish
63772	63774		37132 x 6	21 Red	Red	31616	Chrome
63773	63775		37134 x 6	21 Red	Clear	31616	Chrome
63776	63778		37132 x 6	21 Red	Red	22237	304 Stainless
63777	63779		37134 x 6	21 Red	Clear	22237	304 Stainless
63760	63762		37132 x 6	21 Red	Red	22330	430 Stainless
63761	63763		37134 x 6	21 Red	Clear	22330	430 Stainless

Spring Loaded Rear Light Bar - 2 1/2" Bolt Pattern

- Spring Loaded Rear Light Bar with Six 4" Round LED "GLO" Lights
- Available with 2 1/2" Bolt Pattern, Light Bar Available in Chrome or Stainless
- Available with Chrome Plastic Light Bezel with Visor (Item # 10483) and Rubber Grommet (Item # 31515)



GloLight™

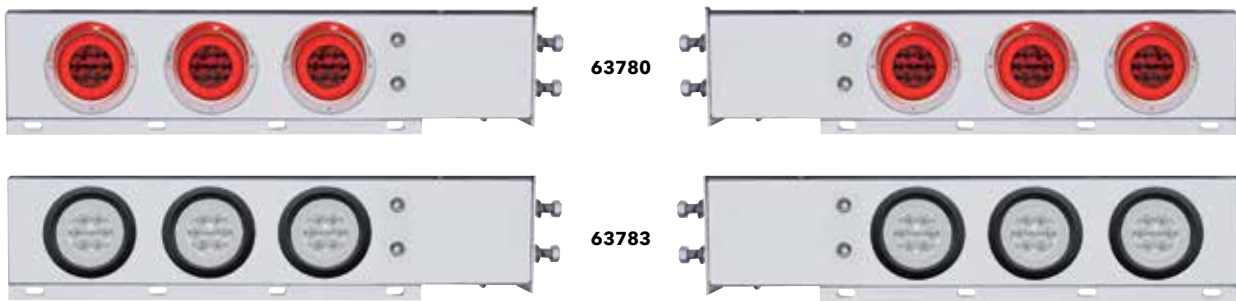

Item # with Visor	Item # with Grommet	LED Lights				Rear Light Bar	
		4" LED "GLO" Light	Item #	LEDs	Lens	Item #	Finish
63780	63782		37132 x 6	21 Red	Red	31615	Chrome
63781	63783		37134 x 6	21 Red	Clear	31615	Chrome
63764	63766		37132 x 6	21 Red	Red	22301	430 Stainless
63765	63767		37134 x 6	21 Red	Clear	22301	430 Stainless

Spring Loaded Rear Light Bar - 3 3/4" Bolt Pattern

- Spring Loaded Rear Light Bar with Six 6" Oval LED "GLO" Lights
- Available with 3 3/4" Bolt Pattern, Light Bar Available in Stainless
- Available with Chrome Plastic Light Bezel with Visor (Item # 10489) and Rubber Grommet (Item # 31506)



GloLight

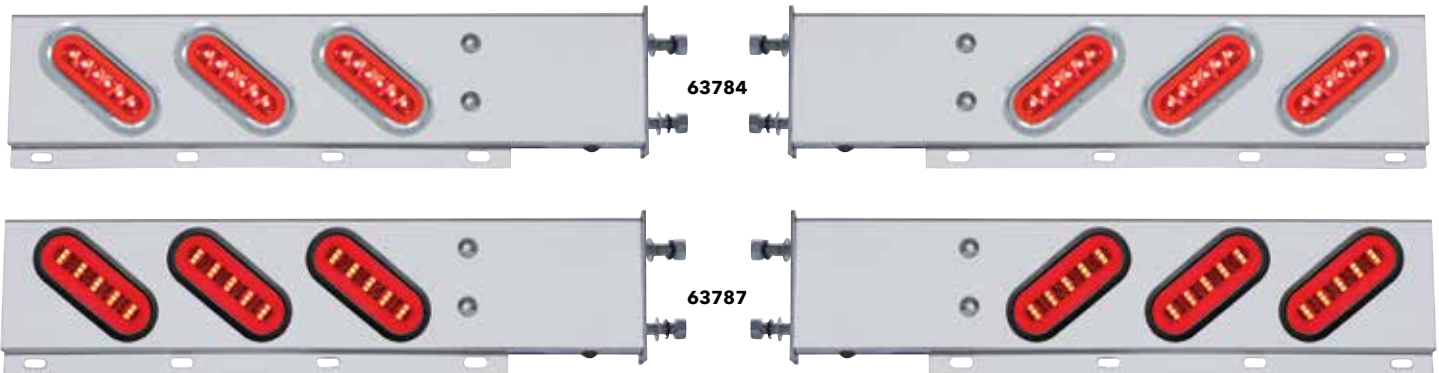

Item # with Visor	Item # with Grommet	LED Lights				Rear Light Bar	
		Oval LED "GLO" Light	Item #	LEDs	Lens	Item #	Finish
63784	63786	 	37128B x 6	22 Red	Red	22303	430 Stainless
63785	63787	 	36924B x 6	22 Red	Clear	22303	430 Stainless

Spring Loaded Rear Light Bar - 2 1/2" Bolt Pattern

- Spring Loaded Rear Light Bar with Six 6" Oval LED "GLO" Lights
- Available with 2 1/2" Bolt Pattern, Light Bar Available in Stainless
- Available with Chrome Plastic Light Bezel with Visor (Item # 10489) and Rubber Grommet (Item # 31506)



GloLight

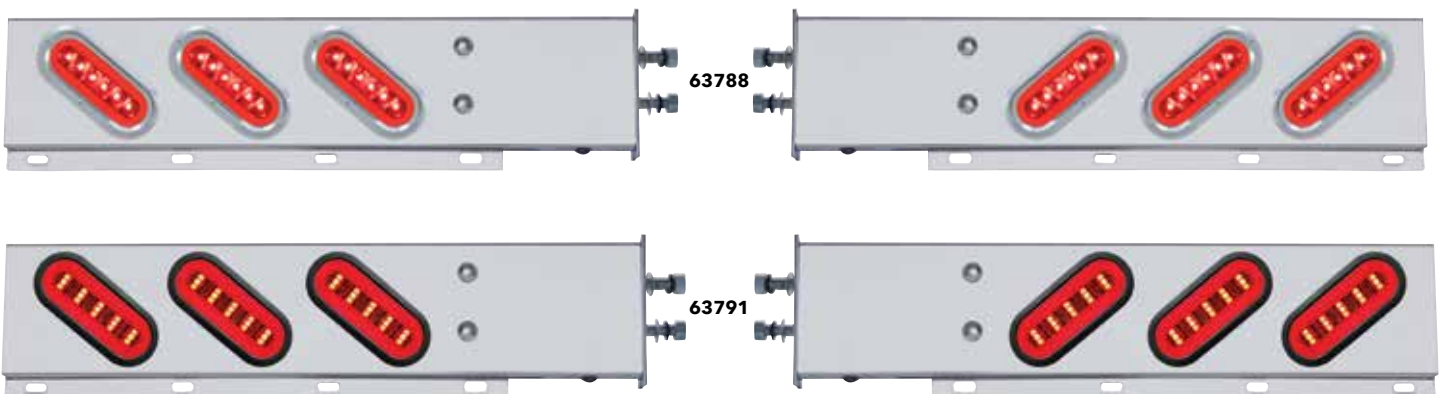

Item # with Visor	Item # with Grommet	LED Lights				Rear Light Bar	
		Oval LED "GLO" Light	Item #	LEDs	Lens	Item #	Finish
63788	63790	 	37128B x 6	22 Red	Red	22304	430 Stainless
63789	63791	 	36924B x 6	22 Red	Clear	22304	430 Stainless

Custom Motorcycle Products



Kit (Item # 36855BRK) Includes



36855



31506



34216

7 LED Oval S/T/T Light Kit

- 7 LED Oval S/T/T Light Kit
- 3 Contact Female Terminal
- Kit Includes Light, Grommet (Item # 31506) and Plug (Item # 34216)
- Recommended Plug: Item # 34216, [Lifetime Warranty](#)

36855BRK 1 Pc. / Card



Grille Tail Light Bezel for 1933 - 36 Ford Tail Lights

- Great Look For Hot Rods, Rat Rods and Chopper Motorcycles
- Easy Installation, Simply Replaces the Original Tail Light Rim
- Available in Chrome or Gloss Black

110427 **Chrome** - 1 Pc. / Box

110428 **Gloss Black** - 1 Pc. / Box

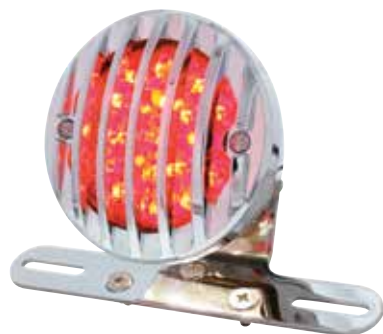

86858



86859



86860



86861

Custom Motorcycle Products



Motorcycle LED Rear Fender Tail Light with Grille Bezel

- Great Look for Any Chopper, Bobber, and Cafe Racer
- Die Cast Metal Grille Bezel Protects Tail Light Lens
- Complete LED 12 Volt Tail Light with LED License Plate Illuminator Lens
- Design Is Based on the Iconic 1933-36 Ford Tail Light
- Sold Each

Item #	Style	Rim	Bracket	Pack
86858	Red LED Lens	Chrome	Chrome	1 Pc./Box
86859	Red LED Lens	Black	Black	1 Pc./Box
86860	Smoke Lens	Chrome	Chrome	1 Pc./Box
86861	Smoke Lens	Black	Black	1 Pc./Box

Custom Motorcycle Products



Motorcycle LED "Bobber" Style Horizontal Tail Light with Grille Bezel

- Great Look for Any Chopper, Bobber, and Cafe Racer
- Die Cast Metal Grille Bezel Protects Tail Light Lens
- Complete LED 12 Volt Tail Light with LED License Plate Illuminator Lens
- Design Is Based on the Iconic 1933-36 Ford Tail Light
- Sold Each

Item #	Style	Rim	Bracket	Pack
86850	Red LED Lens	Chrome	Chrome	1 Pc./Box
86851	Red LED Lens	Black	Black	1 Pc./Box
86852	Smoke Lens	Chrome	Chrome	1 Pc./Box
86853	Smoke Lens	Black	Black	1 Pc./Box

Custom Motorcycle Products



Motorcycle LED "Bobber" Style Vertical Tail Light with Grille Bezel

- Great Look for Any Chopper, Bobber, and Cafe Racer
- Die Cast Metal Grille Bezel Protects Tail Light Lens
- Complete LED 12 Volt Tail Light with LED License Plate Illuminator Lens
- Design Is Based on the Iconic 1933-36 Ford Tail Light
- Sold Each

Item #	Style	Rim	Bracket	Pack
86854	Red LED Lens	Chrome	Chrome	1 Pc./Box
86855	Red LED Lens	Black	Black	1 Pc./Box
86856	Smoke Lens	Chrome	Chrome	1 Pc./Box
86857	Smoke Lens	Black	Black	1 Pc./Box

TERMS & CONDITIONS / ORDERING GUIDELINES / FREIGHT

IMPORTANT: PLEASE REVIEW CAREFULLY

New Accounts

Initial minimum buy-in is \$2,000 (or to be determined by United Pacific Industries, UPI hereafter). All initial orders must be prepaid in advance by Cashier's Check or VISA/MC. All new/potential accounts must complete a UPI "New Customer Info/Credit Form" and follow the Dealer Qualification Instructions. Upon completion of the credit application, approved accounts will be assigned payment terms of NET 30 Days (from invoice date). Accounts denied a credit line will be required to prepay in advance by Cashier's Check or VISA/MC.

Payment Terms:

Term Accounts

Accounts with NET 30 Days terms are required to submit payment within the 30 days from the date of invoice. Acceptable forms of payment include checks, ACH (Automated Clearing House), or wire transfer.

A service charge of 1.5% per month will be imposed on invoices not paid within the 30 day term. Delinquent accounts will be required to pay Cash-In- Advance (CIA). Checks will be accepted but orders will not be released until the check is cleared by the bank. Past due invoices will delay current orders. Please check with UPI on your account status when placing an order.

Credit Cards

Accounts denied credit terms may pay by Visa or MasterCard. Credit card will be charged upon shipment. Credit card payments will not be accepted once an order has been shipped. UPI does not accept American Express or Discover card.

COD

A \$9.00 fee will be assessed per COD box for all FedEx/UPS COD shipments. Truck COD shipment fees are to be determined later by trucking company.

Returned Checks:

A \$30 NSF (Non Sufficient Fund) fee will be assessed on each incidence a check is returned to UPI.

ORDERING GUIDELINES

Placing Orders: New orders may be placed by any of the following methods

1. Fax: **888.986.5988**
2. E-mail: sales@upauto.com
3. Telephone: In order to minimize errors, customers are encouraged to submit their orders by fax or email. Telephone orders should be limited to smaller orders such as add-ons to orders already submitted and/or fill-ins occurring between larger restocking orders.

Changes to Orders:

Whenever possible, revisions to orders - additions or deletions of items - should also be submitted via fax or email to reduce the possibility of errors.

Additions/Deletion of items will only be accepted within 48 hours after the initial order date and/or before 12:00PM on the date of the shipment. Additions of items placed after the 48 hours time period will be considered a new order and adhere to a new order freight prepaid policy. Deletions of item cannot happen after the 48 hours time period and/or after 12:00PM on the date of the shipment. Please note additions and/or deletions of items will delay the shipment date.

Canceling Orders:

Cancellation of orders must be submitted via fax or email within 24 hours of the order date. If the order has already shipped it will be the customers responsibility to return the order at the customers own expense. A restocking fee may apply, please see "Return" policy for further detail.

Backorders:

Customers have the option of having their backorders shipped or canceled. UPI will notify customer as to availability of backorders and will be able to ship any backorder items customer still needs as part of their next stock order. UPI reserves the right to cancel backorders that are 6 months or older from the initial invoice date.

Minimum Order:

A minimum order of \$50.00 is required. Orders below \$50.00 will be assessed a minimum order fee of \$10.00.

Packaging:

A 10% service charge will be added to orders with special packaging or UPC barcoding requirements.

Lead Times:

Standard lead time for all United Pacific orders is 1-3 business days from the receipt of the purchase order. Larger orders may require a lead time of up to 5 business days. Transit time of 3-5 business days must be considered when placing orders. UPI cannot be responsible for delays in shipment after an order leaves our warehouse. UPI will work to resolve delays with freight forwarding firms, however, delays do arise from time to time due to weather and unforeseen circumstances beyond UPI's control. Express order are exempted; please view Freight/Shipping Policy for further detail.

Order Confirmation:

United Pacific will acknowledge receipt of orders by email/fax/ telephone within 1 business day of receipt. If confirmation is not received, please contact UPI to ensure your order was received.

FREIGHT

Prepaid Freight:

Stock orders between \$50 and \$999.99 (US Lower 48 States), **\$50 and \$2499.99 (Alaska and Hawaii)**, **\$50 and \$1499.99 (Canada)**, [all price net US\$], will be shipped FOB Long Beach, California. Stock orders of \$1,000 (US Lower 48 States), **\$2500 (Alaska and Hawaii)**, **\$1500 (Canada)**, [based on UPI current pricing], or more will be shipped Freight Prepaid Ground to a single location only. (See exception for Oversize Items*). Express Air orders, Special Net Pricing orders, and Special Quote Pricing orders are excluded. United Pacific reserves the right to select the carrier of our choice. Customers may select the carrier of their choice at their own expense, negotiated rates and insurance. If customers elect to choose their own freight carrier, orders will be shipped via FREIGHT COLLECT.

Oversize Item Freight Policy – Applies to 1932 Ford car & truck body shell assemblies, 1932 Ford car & truck body parts such as floor assembly, roof, door, fender, quarter panel, grille, bulk rail gutter, bulk roof tack strip, chassis & frame, wheels & tire, and any exceptionally large or heavy item.

1. Freight will be prepaid by United Pacific if the total order of all items exceeds \$4,000 (US Lower 48 States) or **\$5000 (Hawaii, Alaska and Canada)**, [all price net US\$]. There will not be additional charges for these items included on the order.
2. Freight will be prepaid by United Pacific if a customer orders a total of \$2,500 (US Lower 48 States) or **\$3500 (Hawaii, Alaska and Canada)**, [all price net US\$], of PB 379 fenders, 60" or longer exhaust, and/or 18"+ Longer Saddle Boxes only. If the order is below \$2,500 (US Lower 48 States) or **\$3500 (Hawaii, Alaska and Canada)**, United Pacific will add freight charges to the order for the oversize items.

Will Call Orders:

Will Call orders can be picked up 2 - 4 hours after placing the order. Customers should always call ahead to confirm when order will be ready to pick up.

SHIPPING POLICY / CLAIMS

IMPORTANT: PLEASE REVIEW CAREFULLY

SHIPPING POLICY

International Shipments:

Shipments to locations outside the continental United States will be shipped to the customer's shipping agent or broker within the continental United States in accordance with the US freight policy. International customers will be responsible for the duties and taxes of their respective country.

Express Orders:

All express orders, such as Next Day, Second Day, 3 Day Service & Will Call, must be faxed/emailed. Order confirmation will be faxed to the customer for final approval. If confirmation is not received, please contact UPI to ensure your order was received. Customers are required to sign off on express orders and fax confirmation back to UPI. Cut off for express order is 12:00PM. Express orders received after 12:00PM may or may not ship the same day. Please call UPI to confirm projected shipping date or will call time.

Due to the high cost of express shipments, customer may request UPI to call to confirm freight charges. If customer does not request confirmation, UPI will ship the express order.

Drop Shipments:

All drop shipment orders will be assessed a 5% processing fee. Drop shipment processing fee will be automatically added to the invoice without notice. All drop shipment orders must be faxed in. No freight allowance or prepaid freight will be permitted for any drop shipments, thus, all drop ship orders, regardless of order size, are FOB Long Beach, CA.

CLAIMS

General Policy:

All claims (Shortage, Mis-Shipped, Damage, Overage, Customer Error & Billing Error) must be submitted to UPI within 3 business days of the receipt of shipment. Claims submitted beyond 3 business days of the receipt of shipment will be voided by UPI.

On all shipments, the person who signs and receives the shipment is responsible for noting on the Bill of Lading, in writing, whether any boxes arrived damaged or shorted. Failure to do so will void all claim rights between all parties. UPI will have no recourse against the trucking company if customer does not note any damages or shortages on the Bill of Lading.

The customers receiving department must count and sign for the exact number of boxes received. Failure to follow the above instructions will void all claim rights between all parties.

Shortages / Mis-Ships / Damages

While UPI strives to fill every order with 100% accuracy, on occasion an item may get shipped in error or get damaged during shipping. In the event this occurs, please follow the process below. Note: This type of claim must be reported to UPI within three (3) business days of receiving the order.

1. Contact the United Pacific office to initiate the claim. To make it easy for you we have two acceptable methods for requesting the claim:

- By e-mail : returns@upauto.com
- By fax : [888.986.5988](tel:888.986.5988)

* **Note: To ensure you receive a timely credit, we cannot accept claim requests by phone.**

2. You will be required to provide the following information:

- Your business name
- Contact name and telephone number (in case we have questions)
- Date the order was received
- A copy of the Packing List / Invoice noting the item number and quantity that was shipped in error or damaged during shipping.
- Special instructions you have for us.

3. UPI will send a return label so you can ship the items back.

4. Once we receive the miss-shipped/damaged item(s) a credit will be issued to your account on the next billing cycle.

5. Shortages will be credit to the Customers' account, unless customer would like the shortages replaced.

Overages:

UPI strives to provide our customers with the best customer service and products, in turn we would greatly appreciate any help from customer in notifying UPI of any shipping overages. Customers will be offered the option of retaining the merchandise or returning the merchandise to UPI at UPI's expense. If the items are to be returned, an RMA number and return shipping label will be provided.

Customer Errors:

Any item or quantity ordered in error by the customer may be returned by contacting UPI for a RMA No.

1. To make it easy for you we have two acceptable methods for requesting the RMA:

- By e-mail: returns@upauto.com
- By fax: [888.986.5988](tel:888.986.5988)

* **Note: To ensure you receive a timely RMA credit, we cannot accept RMA requests by phone.**

2. You will be required to provide the following information.

- * Your business name
- * Contact name and telephone number (in case we have questions)
- * A list of the items number and quantity ordered in error
- * Special instructions you have for us

3. UPI will review the request to ensure the products are within the return period.

4. Once we have validated the request, United Pacific will issue an RMA number to the customer. In issuing the RMA approval, the following conditions will apply :

- Returned items are subject to a 20% re-stocking fee.
- Return shipping costs are the responsibility of the customer.
- Items must not have any retail/price sticker on exterior packaging or they will be returned to the customer at customer's expense and no credit given.
- Items must be in good condition with original packaging intact or they will be returned to the customer at customer's expense and no credit given.
- Allow up to 30 days for the credit to be issued from the time the returned items are received.

Billing Errors:

Billing errors should be reported to UPI within 3 business days of invoice receipt. Customers are asked to provide the invoice number, part number, and quantities in question. Once verified, UPI will issue a credit or an invoice for the difference in billing error.

WARRANTY POLICY / RETURNS

IMPORTANT: PLEASE REVIEW CAREFULLY

WARRANTY POLICY

General Policy:

UPI offers a NO HASSLE WARRANTY RETURN policy to all our customers. Warranty claims can only be submitted through an authorized UPI Distributor. UPI warranty is not transferable and applies to the original installation and purchase only. In no event shall UPI be liable for incidental or consequential damages, nor shall UPI be liable for any claims or damages arising out of or connected with the UPI warranty exceed the purchase price of the products. There are no warranties, expressed or implied (including any warranty of merchantability or fitness) that extend beyond this warranty. The warranty does not apply to costs associated with the loss of use of the product, loss of time, inconvenience, commercial loss, incidental or consequential damages. UPI reserves the right to alter the designs of products without assuming any obligation to modify previously manufactured products and will only replace warranted products with redesigned products.

Warranty does not apply to merchandise that has been drilled, cut, welded, modified in any way or installed contrary to normal installation and usage. In addition, UPI cannot be held liable for damages caused by road hazards, accidents, misuse, neglect, abuse or corrosive environments including acid washes and highway snow/ice chemicals which can cause discoloration and corrosion in aluminum, chrome, stainless steel and light products. UPI reserves the right to credit returned merchandise at the initial purchase price or at the current selling price, which price ever is lower.

Aluminum / Chrome / Stainless Steel Products:

All aluminum, chrome, and stainless steel products carry a limited 6 month warranty (from invoice date) against defects in material or workmanship.

Lighting Products:

Incandescent

All incandescent lighting products carry a limited 12 month warranty (from invoice date) against defects in material or workmanship. The limited 12 month warranty does not apply to several applications, such as, buses, construction equipment, and off road vehicles.

LED

All LED lighting products carry a specific Limited Warranty (from invoice date) against defects in material or workmanship.

- LED with vehicle specific application is limited lifetime warranty to an original purchaser with receipt. Examples of lifetime warranty product: CTL5720LED CTL5720LED for 1957 Chevy, FTL3201LED-L for 1932 Ford.
- LED Marker, 2", 2-1/2", 4", 7", Oval & Square Lights - Varies from 2 years to 10 years to Limited Lifetime, depending on specific item. The housing, bezel or mounting base on any light made from Chrome/Stainless carries a 6 month limited warranty.
- LED Cab Lights and Kits, Double/Single Stud Turn Signal and PB/KW/FL/VL or non-make Turn Signals and any/all Strip Lights - Varies from 2 years to 10 years to Limited Lifetime, depending on specific item. The housing, bezel or mounting base on any light made from Chrome/Stainless carries a 6 month limited warranty.
- LED Beacon, Driving, Headlights, Work & Warning Lights - Varies from 6 months to 3 years. The housing, bezel or mounting base on any light made from Chrome/Stainless carries a 6 month limited warranty.
- All LED Accessory Lights (Honda, Stainless Steel Double/Single face Lights, Interior Lights, License Plate Lights, and any Accent Lights. The housing, bezel or mounting base on any light made from Chrome/Stainless carries a 6 month limited warranty.

RETURNS

General Policy:

All returns must be authorized by UPI. All return requests must be faxed or e-mailed (returns@upauto.com) A RMA number (Return Merchandise Authorization Number) will be provided. Returns not possessing a valid RMA number are subject to rejection and will be returned to sender at the customer's expense.

All customers are encouraged to use the Warranty RMA Claim Form.

Defective Goods / Warranty Return:

UPI offers our customers a No Hassle Warranty Return. Please follow the instructions below for requesting a RMA for defective goods:

1. If any warranty issues occur, simply contact the UPI for RMA number To make it easy for you we have two acceptable methods for requesting the RMA:
 - By e-mail: returns@upauto.com
 - By fax: **888.986.5988**
 - **Note: To ensure you receive a timely RMA credit, we cannot accept RMA requests by phone.**
2. You will be required to provide the following information:
 - Your business name
 - Contact name and telephone number (in case we have questions)
 - A list of the defective item number and quantity with the nature/ reason of the defect
 - Special instructions you have for us
 - The enclosed fax form may be used for your convenience to request an RMA
3. UPI will review the request to ensure the products are within the stated warranty period.
4. Once we have validated the warranty items, a RMA confirmation, listing the items and cost will be faxed to the customer within 3 business days. UPI will process the credit to your account within 30 days.

Note: There will be no need to return the warranty product to us. However, from time to time, UPI may require some warranty products to be shipped back so we may analyze the cause of the failure. All warranty products that are required to be shipped back will be freight prepaid by UPI.

Stock Return

United Pacific Industries encourages all customers to regularly monitor the sales volume and stock level of their inventory items. As sales trends may slow the movement of specific items, our hope is that those items are featured as "close-out specials" as to minimize stock returns. We also understand that the customer, from time to time, may accumulate over-stock items and desire to return those. Therefore, we have adopted the following policy below.

NOTE:

- Items must have been purchased by the dealer requesting the stock return.
- Items must have been purchased within the preceding 12 months.
- Items that have been discontinued will not be considered for return.

1. Contact the United Pacific office for RMA number We have 2 acceptable methods for requesting the RMA:

By e-mail : returns@upauto.com

By fax : **888.986.5988**

***Note: To ensure you receive a timely RMA credit, we cannot accept RMA requests by phone.**

RETURNS / CATALOGS / DISCLAIMER

IMPORTANT: PLEASE REVIEW CAREFULLY

2. You will be required to provide the following information:

- Your business name
- Contact name and telephone number (in case we have questions)
- A list of defective items: Item numbers and quantity of each
- Special instructions you have for us

3. Your claim will be reviewed within 5 business days and you will be contacted by your sales representative who will discuss solutions to liquidate these slow moving items.

4. In the event United Pacific and the customer agree to a credit in lieu of returning the items, this credit will be issued within 10 business days.

5. In the event items are returned by the customer, United Pacific will issue an RMA number to the customer. In issuing the RMA approval, the following conditions will apply:

- Returned items are subject to a 20% re-stocking fee.
- Return shipping costs are the responsibility of the customer.
- Items must not have any retail/price sticker on exterior packaging or they will be returned to the customer at customer's expense and no credit given.
- Items must be in good condition with original packaging intact or they will be returned to the customer at customer's expense and no credit given.
- Allow up to 30 days for the credit to be issued from the time the returned items are received.

6. Stock returns may be requested throughout the year and are subject to a maximum of 5% of prior year annual purchases.

Closeout/Discontinue Items:

UPI will not warranty or accept returns on Closeout/Discontinue items.

Procedure:

An inventory of the merchandise being returned must accompany each return. The RMA number should be prominently displayed on each carton/box.

All Returns must be returned freight prepaid.

Ship Returns to:

United Pacific Industries
Attn: Returns Department
3788 E. Conant St.
Long Beach, CA 90808

RMA's:

Outstanding RMA's will be automatically canceled if not used within 30 days of issuance.

CATALOGS

General Policy:

UPI will send a set of catalogs and price lists upon the arrival any new catalogs and price list. Included in the mailing will be a Catalog Order Form in which customers can request additional copies.

Catalog/CD Request:

UPI provides additional catalogs/CD's to our customers free of charge. Customer must submit their request on a UPI Catalog Order Form or add the request to their regular restocking order. Requests for additional catalogs/CD's should be submitted along with the regular restocking orders to avoid additional freight charges. Due to the availability of catalogs/CD's, customer's request may be limited to certain quantity. Catalogs/CD's will be shipped along with the customers' order. Customer may request the catalogs be shipped separately, but customer will be responsible for the freight charge.

Picture Request

All UPI item pictures are taken professionally by our marketing department. Item pictures can be downloaded online at www.upauto.com. Item pictures not posted online can be requested by sending an email to e-mail graphic@upauto.com. All picture requests must state the item no and the format of the picture file, i.e jpeg or high resolution. UPI has over 20,000 SKU's and therefore does not have a CD with all the items.

DISCLAIMER

United Pacific Industries reserves the right to amend or update our Policies & Procedures without notice.

RMA FORM SAMPLE



DEFECTIVE GOODS / WARRANTY CLAIM FORM

UNITED PACIFIC INDUSTRIES, INC.
3788 E. CONANT ST.
LONG BEACH, CA 90808
DIRECT: (562) 421-9888
TOLL FREE: (800) 790-6988
TOLL FREE FAX: (888) 986-5988

Date: _____
Company Name: _____
Address: _____
City, State, Zip: _____
Contact Name: _____
Phone Number: _____
Fax Number: _____
E-mail: _____

List defective items below:

Item #	Quantity	Description	Reason for Defect	Date sold to Customer
1				
2				
3				
4				
5				
6				
7				
8				
9				
10				

Any special notes / instructions for United Pacific (list here):

File your claim at:
by email - returns@upauto.com
by fax - (888) 986-5988

Note: we cannot accept any phone request

Internal Use Only

Date Received: _____	Final RMA _____
RMA Approval Date: _____	Credit Amount: _____
RMA Number: _____	Approved By: _____

ITEM#	PAGE#	ITEM#	PAGE#	ITEM#	PAGE#	ITEM#	PAGE#	ITEM#	PAGE#
10034B	7	21147	17	31162	17	36507	46	36782	9
10064B	12	21148	4	31169	33	36508	46	36783	9
10112	18	21164	3	31171	8	36509	40	36827B	14
10190B	7	21198	3	31172	8	36510	29	36828	19
10239	42	21199	3	31201	51	36511	30	36829	19
10241	27, 32	21204	20	31202	51	36514	9	36830	19
10249	42	21205	3, 17	31238	33	36514B	9	36831	19
10254	31	21206	15	31327	28	36515	9	36832	30
10259	32	21207	23	31444	2	36515B	9	36832B	30
10261	31, 42	21208	23	31445	20	36516	14	36832BRK	19
10263	42	21264	24	31446	20	36517B	14	36838	9
10278	27, 32	21265	24	31447	20	36518B	2, 14	36839	9
10300B	18	21457	15	31448	20	36519B	14	36840	9
10306	27	21458	4	31496	29	36520B	2, 14	36841	9
10307	21	21459	3	31513	45	36521B	14	36842	9
10308	32	21466	20	31514	45	36522	2	36855BRK	54
10548B	7	21467	3	31519	17	36523	2	36888	2
10549B	7	21468	3, 17	31615	52	36524	27	36897	13
10550B	18	21469	27	31616	52	36525	27, 47	36898	13
10551B	12	21471	17	32170B	44	36525B	47	36905	13
10552B	12	21472	17	32353	28	36526	27	36906	13
10562B	12	21473	17	32354	28	36527	27, 47	36907	13
10563B	7	21793	33, 43	32778	14	36527B	47	36908	13
10564B	18	21796	15, 33, 43	34122	29	36528	19	36924B	53
10569B	7	21797	15	34217B	12	36529	19	37128B	53
10572B	12	21910	33, 43	34498	27	36530	19	37132	52
10711	44	21911	28, 33, 43	34499	27	36531	19	37134	52
10752	16	21912	28, 33, 43	35800	38	36532	19	39397	14
10752B	16	21913	28, 33, 43	35801	38	36607	39	39445	49
10924	48	21915	33, 43	35806	38	36608	39	39446	49
10934	15, 22	21916	33, 43	35807	38	36609	39	39652BRK	30
10945	22	22237	52	36472	36	36610	39	39817	40
10963	11, 22	22252	27	36473	36	36611	23	39817B	40
10964	48	22253	27	36474	36	36612	23	39818	40
11137B	16	22301	52	36475	36	36613	23	39818B	40
20102	8	22303	53	36476	36	36614	23	39819	40
20481	41	22304	53	36477	36	36615	23	39819B	40
20482	41	22330	52	36478	36	36616	23	39820B	40
20483	41	22960	28	36479	36	36646	14	40897	5
20484	41	22961	28	36480	36	36647	14	40900	5
20485	41	22962	28	36481	36	36648	14	41445	44
20486	41	22963	28	36482	36	36649	14	41449	51
20706	11	22974	22	36483	36	36652	47	41677	30
20707	11	22975	22	36484	35	36652B	47	41678	30
20899	11	22976	22	36485	35	36654	47	41688	30
20909	23	22977	22	36486	35	36654B	47	41694	5
20910	23	22978B	28	36487	35	36749	10	41697B	4
20911	34	29068	24	36488	35	36750	10	41698B	4
21076	3	30608B	10	36489	35	36751	10	41738	25
21077B	22	30973B	35	36490	35	36752	10	41754	25
21087	11	31120	45	36491	35	36753	10	41755	25
21088	4	31158	50	36492	35	36754	10	41759	25
21089	4	31159	50	36493	35	36755	10	41772	25
21099	27	31160	50	36494	35	36756	10	41850	21
21109	24	31161	50	36495	35	36781	9	41851	15

ITEM#	PAGE#	ITEM#	PAGE#	ITEM#	PAGE#	ITEM#	PAGE#	ITEM#	PAGE#
41852	47	52002B	12	70628	13	70803	16	110307	8
41853	47	52003B	12	70636	25	70804	16	110406	20
42070	15	52004B	12	70646	26	72001	48	110407	20
42198B	44	52005B	12	70647	13	86850	55	110409	20
42199B	44	52006B	12	70648	13	86851	55	110427	54
42224	34	52007B	12	70649	13	86852	55	110428	54
42225	34	63760	52	70650	13	86853	55		
42226	34	63761	52	70655	25	86854	55		
42343	15	63762	52	70657	26	86855	55		
42344	15	63763	52	70664B	13	86856	55		
42350	25	63764	52	70665B	13	86857	55		
42414	5	63765	52	70667	25	86858	54		
42416	21	63766	52	70668	25	86859	54		
42417	25	63767	52	70683	25	86860	54		
42770	11	63772	52	70684	25	86861	54		
42771	23	63773	52	70693	25	88211	6		
42772	23	63774	52	70694	25	88212	6		
42783	11	63775	52	70711	26	88213	6		
42784	23	63776	52	70712	1	88214	6		
42785	23	63777	52	70713	1	88217	6		
42791B	47	63778	52	70714	1	88218	6		
42792B	47	63779	52	70715	1	88219	6		
42813	41	63780	52	70716	1	88220	6		
42814	41	63781	52	70717	1	88221	6		
42815	41	63782	52	70718	1	88222	6		
42816	41	63783	52	70719	1	88237	10, 33		
42817	41	63784	53	70720	1	88238	6		
42818	41	63785	53	70721	1	88239	6		
42819	41	63786	53	70722	1	88257	33		
42820	41	63787	53	70723	1	88258	33		
46101	37	63788	53	70724	1	88259	6		
46153	4	63789	53	70725	1	89998	51		
49998	18	63790	53	70726	1	90050	5		
49999	16, 18	63791	53	70727	1	90322	16		
50033	31	70176	43	70728	1	90323	16		
50034	26	70405	10	70729	1	90630	49		
50037	26	70406	10	70730	1	90656	28		
50038	26	70407	31	70731	1	90661	43		
50047	12	70408	31	70732	1	90800	7		
50064B	36	70409	31	70733	1	90801	7		
50065	16	70588	13	70734	1	90802	7		
50109	16	70591	43	70735	1	90803	7		
50112	5	70592	43	70736	1	90808	7		
50113	16	70593	43	70737	1	90809	7		
50114	31	70594	43	70738	1	90810	7		
50115	26	70595	43	70739	1	91500	24		
50116	26	70596	43	70740	1	91501	24		
50117	26	70597	43	70741	1	95000	15		
50118	37	70607	13	70742	1	95001	15		
50119	33, 48	70608	13	70743	1	99051	49		
50124	37	70609	13	70744	25	99074	26		
50128	37	70610	13	70745	48	99087	18		
50129	37	70623	13	70746	48	99098	18		
52000B	12	70624	13	70801	8	99099	28		
52001B	12	70627	13	70802	8	99101	31		